

EUROPEAN PATENT OFFICE
U.S. PATENT AND TRADEMARK OFFICE

CPC NOTICE OF CHANGES 1713

DATE: JANUARY 1, 2025

PROJECT MP12363

The following classification changes will be effected by this Notice of Changes:

<u>Action</u>	<u>Subclass</u>	<u>Group(s)</u>
SCHEME:		
Titles Changed:	A61F	2/00, 2/02, 2/04, 2/062, 2/08, 2/12, 2/14, 2/20, 2/2412, 2/28, 2/2875, 2/46, 2/52, 2/82, 2/88, 2/91
	A61F	4/00
	A61F	5/00, 5/01, 5/02, 5/03, 5/04, 5/05, 5/30, 5/34, 5/37, 5/41, 5/44, 5/443, 5/56
	A61F	6/00, 6/18, 6/202
	A61F	7/00, 7/08
	A61F	9/00, 9/02, 9/04, 9/06
	A61F	13/04, 13/10, 13/15, 13/36, 13/38, 13/472, 13/476, 13/49, 13/505, 13/51, 13/534, 13/535, 13/581, 13/62
	A61F	15/00
DEFINITIONS:		
Definitions New:	A61F	5/02, 5/03, 5/30, 5/34, 5/37, 5/41, 5/443, 5/56
	A61F	6/202
	A61F	7/08
	A61F	13/38, 13/505, 13/534, 13/581
Definitions Modified:	A61F	2/00, 2/02, 2/04, 2/062, 2/08, 2/12, 2/14, 2/20, 2/2412, 2/28, 2/2875, 2/82, 2/88, 2/91
	A61F	4/00
	A61F	5/00, 5/44
	A61F	6/00
	A61F	7/00
	A61F	9/00, 9/02, 9/04, 9/06
	A61F	11/00
	A61F	13/02, 13/04, 13/10, 13/15, 13/476, 13/51, 13/62
	A61F	15/00

No other subclasses/groups are impacted by this Notice of Changes.

CPC NOTICE OF CHANGES 1713

DATE: JANUARY 1, 2025

PROJECT MP12363

This Notice of Changes includes the following *[Check the ones included]:*

1. CLASSIFICATION SCHEME CHANGES

- A. New, Modified or Deleted Group(s)
- B. New, Modified or Deleted Warning(s)
- C. New, Modified or Deleted Note(s)
- D. New, Modified or Deleted Guidance Heading(s)

2. DEFINITIONS

- A. New or Modified Definitions (Full definition template)
- B. Modified or Deleted Definitions (Definitions Quick Fix)

3. REVISION CONCORDANCE LIST (RCL)

4. CHANGES TO THE CPC-TO-IPC CONCORDANCE LIST (CICL)

5. CHANGES TO THE CROSS-REFERENCE LIST (CRL)

CPC NOTICE OF CHANGES 1713

DATE: JANUARY 1, 2025

PROJECT MP12363

1. CLASSIFICATION SCHEME CHANGES

A. New, Modified or Deleted Group(s)

SUBCLASS A61F - FILTERS IMPLANTABLE INTO BLOOD VESSELS; PROSTHESES; DEVICES PROVIDING PATENCY TO, OR PREVENTING COLLAPSING OF, TUBULAR STRUCTURES OF THE BODY, e.g. STENTS; ORTHOPAEDIC, NURSING OR CONTRACEPTIVE DEVICES; FOMENTATION; TREATMENT OR PROTECTION OF EYES OR EARS; BANDAGES, DRESSINGS OR ABSORBENT PADS; FIRST-AID KITS (dental prosthetics A61C)

<u>Type*</u>	<u>Symbol</u>	<u>Indent Level Number of dots (e.g. 0, 1, 2)</u>	<u>Title</u> <u>“CPC only” text should normally be enclosed in {curly brackets}**</u>	<u>Transferred to#</u>
M	A61F 2/00	0	Filters implantable into blood vessels; Prostheses, i.e. artificial substitutes or replacements for parts of the body; Appliances for connecting them with the body; Devices providing patency to, or preventing collapsing of, tubular structures of the body, e.g. stents (dental prostheses A61C 13/00; artificial kidneys A61M 1/14; artificial hearts A61M 60/00)	
M	A61F 2/02	1	Prostheses implantable into the body	
M	A61F 2/04	2	Hollow or tubular parts of organs, e.g. bladders, tracheae, bronchi or bile ducts (A61F 2/18, A61F 2/20 take precedence; instruments specially adapted for placement or removal of stents or stent-grafts A61F 2/95)	
M	A61F 2/062	4	{Apparatus for the production of blood vessels made from natural tissue or with layers of living cells}	
M	A61F 2/08	2	Muscles; Tendons; Ligaments	
M	A61F 2/12	2	Mammary prostheses	
M	A61F 2/14	2	Eye parts, e.g. lenses or corneal implants; Artificial eyes	
M	A61F 2/20	2	Larynxes; Tracheae combined with larynxes or for use therewith	
M	A61F 2/2412	3	{with soft flexible valve members, e.g. tissue valves shaped like natural valves}	
M	A61F 2/28	2	Bones	
M	A61F 2/2875	3	{Skull or cranium (A61F 2/2803 takes precedence; joints for temporo-mandibular [TM] joints [TMJ] A61F 2/3099)}	
M	A61F 2/46	3	Special tools for implanting artificial joints	
M	A61F 2/52	2	Mammary prostheses (brasieres with stiffening or bust-forming inserts A41C 3/10, A41C 3/14)	

CPC NOTICE OF CHANGES 1713

DATE: JANUARY 1, 2025

PROJECT MP12363

Type*	Symbol	Indent Level Number of dots (e.g. 0, 1, 2)	Title “CPC only” text should normally be enclosed in {curly brackets}**	Transferred to#
M	A61F 2/82	1	Devices providing patency to, or preventing collapsing of, tubular structures of the body, e.g. stents (stent-grafts for tubular structures of the body other than blood vessels A61F 2/04; stent-grafts for blood vessels A61F 2/07; dilators A61M 29/00)	
M	A61F 2/88	3	the wire-like elements formed as helical or spiral coils	
M	A61F 2/91	4	made from perforated sheets or tubes, e.g. perforated by laser cuts or etched holes	
M	A61F 4/00	0	Methods or devices enabling patients or disabled persons to operate an apparatus or a device not forming part of the body	
M	A61F 5/00	0	Orthopaedic methods or devices for non-surgical treatment of bones or joints; Nursing devices (bandages, dressings or absorbent pads A61F 13/00) ; Anti-rape devices}	
M	A61F 5/01	1	Orthopaedic devices, e.g. long-term immobilising or pressure directing devices for treating broken or deformed bones such as splints, casts or braces	
M	A61F 5/02	2	Orthopaedic corsets	
M	A61F 5/03	2	Corsets or bandages for abdomen, test or breast support, with or without pads	
M	A61F 5/04	2	Devices for stretching or reducing fractured limbs; Devices for distractions; Splints	
M	A61F 5/05	3	for immobilising (A61F 5/042 takes precedence)	
M	A61F 5/30	2	Pressure pads	
M	A61F 5/34	3	Pressure pads filled with air or liquid	
M	A61F 5/37	1	Restraining devices for the body or for body parts; Restraining shirts	
M	A61F 5/41	1	Devices for promoting penis erection	
M	A61F 5/44	1	Devices worn by the patient for reception of urine, faeces, catamenial or other discharge (absorbent pads, e.g. sanitary towels, A61F 13/15; drainage appliances for wounds A61M 27/00); Colostomy devices	
M	A61F 5/443	2	having {adhesive seals for securing to the body, e.g. of} hydrocolloid type seals, e.g. gels, starches, karaya gums	
M	A61F 5/56	1	Devices for preventing snoring	
M	A61F 6/00	0	Contraceptive devices; Pessaries; Applicators therefor	
M	A61F 6/18	3	Inserters or removers	

CPC NOTICE OF CHANGES 1713

DATE: JANUARY 1, 2025

PROJECT MP12363

Type*	Symbol	Indent Level Number of dots (e.g. 0, 1, 2)	Title “CPC only” text should normally be enclosed in {curly brackets}**	Transferred to#
M	A61F 6/202	2	{Means specially adapted for ligaturing, compressing or clamping of oviduct or vas deferens}	
M	A61F 7/00	0	Heating or cooling appliances for medical or therapeutic treatment of the human body (hyperthermia using electric or magnetic fields or ultrasound A61N)	
M	A61F 7/08	1	Warming pads, pans or mats; Hot-water bottles	
M	A61F 9/00	0	Methods or devices for treatment of the eyes; Devices for putting in contact-lenses; Devices to correct squinting; Apparatus to guide the blind; Protective devices for the eyes, carried on the body or in the hand (caps with means for protecting the eyes A42B 1/01 81; visors for helmets A42B 3/22; eye baths A61H 35/02; sunglasses or goggles having the same features as spectacles G02C)	
M	A61F 9/02	1	Goggles (for swimming A63B 33/00)	
M	A61F 9/04	1	Eye-masks {; Devices to be worn on the face, not intended for looking through; Eye-pads for sunbathing}	
M	A61F 9/06	2	Masks, shields or hoods for welders	
M	A61F 13/04	1	Plaster of Paris bandages; Other stiffening bandages (A61F 13/06 - A61F 13/15 take precedence; orthopaedic casts made from stiffening bandages A61F 5/01)	
M	A61F 13/10	1	specially adapted for fingers, hands or arms; Finger-stalls; Nail-protectors	
M	A61F 13/15	1	Absorbent pads, e.g. sanitary towels, swabs or tampons for external or internal application to the body; Supporting or fastening means therefor; Tampon applicators	
M	A61F 13/36	2	Surgical swabs, e.g. for absorbency or packing body cavities during surgery (A61F 13/38, A61M 35/006 take precedence)	
M	A61F 13/38	2	Swabs having a stick-type handle {, e.g. cotton tips} (A61M 35/006 takes precedence)	
M	A61F 13/472	4	specially adapted for female use	
M	A61F 13/476	4	characterised by encircling the crotch region of the undergarment, e.g. with flaps	
M	A61F 13/49	3	specially adapted to be worn around the waist, e.g. diapers, nappies	
M	A61F 13/505	2	with separable parts, e.g. combination of disposable and reusable parts (A61F 13/20 {, A61F 13/49003} take precedence)	

CPC NOTICE OF CHANGES 1713

DATE: JANUARY 1, 2025

PROJECT MP12363

<u>Type*</u>	<u>Symbol</u>	<u>Indent Level</u> <u>Number of</u> <u>dots (e.g. 0, 1,</u> <u>2)</u>	<u>Title</u> <u>“CPC only” text should normally be</u> <u>enclosed in {curly brackets}**</u>	<u>Transferred to#</u>
M	A61F 13/51	2	characterised by the outer layers of the pads (A61F 13/20 takes precedence)	
M	A61F 13/534	3	having an inhomogeneous composition through the thickness of the pad (A61F 13/538, A61F 13/539 take precedence)	
M	A61F 13/535	4	inhomogeneous in the plane of the pad, e.g. core absorbent layers being of different sizes ({A61F 13/5323,} A61F 13/537 take precedence)	
M	A61F 13/581	4	{Tab fastener elements combining a adhesive and mechanical fastening}	
M	A61F 13/62	3	{Mechanical fastening means (A61F 13/5611, A61F 13/5616, A61F 13/581 take precedence);} Fabric strip fastener elements, e.g. hook and loop (A61F 13/66 takes precedence)	
M	A61F 15/00	0	Auxiliary appliances for wound dressings; Dispensing containers for dressings or bandages {(packaging of wound dressings A61F 13/00072)}	

*N = new entries where reclassification into entries is involved; C = entries with modified file scope where reclassification of documents from the entries is involved; Q = new entries which are firstly populated with documents via administrative transfers from deleted (D) entries. Afterwards, the transferred documents into the Q entry will either stay or be moved to more appropriate entries, as determined by intellectual reclassification; T = existing entries with enlarged file scope, which receive documents from C or D entries, e.g. when a limiting reference is removed from the entry title; M = entries with no change to the file scope (no reclassification); D = deleted entries; F = frozen entries will be deleted once reclassification of documents from the entries is completed; U = entries that are unchanged.

NOTES:

- **No {curly brackets} are used for titles in CPC only subclasses, e.g. C12Y, A23Y; 2000 series symbol titles of groups found at the end of schemes (orthogonal codes); or the Y section titles. The {curly brackets} are used for 2000 series symbol titles found interspersed throughout the main trunk schemes (breakdown codes).
- U groups: it is obligatory to display the required “anchor” symbol (U group), i.e. the entry immediately preceding a new group or an array of new groups to be created (in case new groups are not clearly subgroups of C-type groups). Always include the symbol, indent level and title of the U group in the table above.
- All entry types should be included in the scheme changes table above for better understanding of the overall scheme change picture. Symbol, indent level, and title are required for all types.
- “Transferred to” column must be completed for all C, D, F, and Q type entries. F groups will be deleted once reclassification is completed.
- When multiple symbols are included in the “Transferred to” column, avoid using ranges of symbols in order to be as precise as possible.
- For administrative transfer of documents, the following text should be used: “<administrative transfer to XX>”, “<administrative transfer to XX and YY simultaneously>”, or “<administrative transfer to XX, YY, ...and ZZ simultaneously>” when administrative transfer of the same documents is to more than one place.
- Administrative transfer to main trunk groups is assumed to be the source allocation type, unless otherwise indicated.

CPC NOTICE OF CHANGES 1713

DATE: JANUARY 1, 2025

PROJECT MP12363

- Administrative transfer to 2000/Y series groups is assumed to be “additional information”.
- If needed, instructions for allocation type should be indicated within the angle brackets using the abbreviations “ADD” or “INV”: <administrative transfer to XX ADD>, <administrative transfer to XX INV>, or <administrative transfer to XX ADD, YY INV, ... and ZZ ADD simultaneously>.
- In certain situations, the “D” entries of 2000-series or Y-series groups may not require a destination (“Transferred to”) symbol, however it is required to specify “<no transfer>” in the “Transferred to” column for such cases.
- For finalization projects, the deleted “F” symbols should have <no transfer> in the “Transferred to” column.
- For more details about the types of scheme change, see CPC Guide.

DATE: JANUARY 1, 2025

PROJECT MP12363

2. A. DEFINITIONS (new)

A61F5/02

References

Informative references

Attention is drawn to the following places, which may be of interest for search:

Arm-rests for use as writing aids	B43L15/00
-----------------------------------	---------------------------

A61F5/03

References

Informative references

Attention is drawn to the following places, which may be of interest for search:

Brassières	A41C 3/00
Trusses	A61F 5/24
Pressure pads	A61F 5/30

DATE: JANUARY 1, 2025

PROJECT MP12363

A61F5/30**References*****Application-oriented references***

Examples of places where the subject matter of this place is covered when specially adapted, used for a particular purpose, or incorporated in a larger system:

Corn-pads or corn-rings	A61F13/06
-------------------------	---------------------------

Informative references

Attention is drawn to the following places, which may be of interest for search:

Tourniquets	A61B 17/132
-------------	-----------------------------

A61F5/34**References*****Informative references***

Attention is drawn to the following places, which may be of interest for search:

Valves specially adapted for medical use	A61M 39/00
Connection of valves to inflatable elastic bodies	B60C 29/00
Valves per se	F16K

DATE: JANUARY 1, 2025

PROJECT MP12363

A61F5/37

References

Informative references

Attention is drawn to the following places, which may be of interest for search:

Handcuffs	E05B 75/00
-----------	----------------------------

A61F5/41

References

Informative references

Attention is drawn to the following places, which may be of interest for search:

Penis implants	A61F 2/26
Massage of the genitals	A61H 19/00

A61F5/443

References

Informative references

Attention is drawn to the following places, which may be of interest for search:

Adhesives or sealing pads therefor	A61L 24/00
------------------------------------	----------------------------

DATE: JANUARY 1, 2025

PROJECT MP12363

A61F5/56

References

Informative references

Attention is drawn to the following places, which may be of interest for search:

Devices for influencing the respiratory system by gas treatment	A61M 16/00
---	----------------------------

A61F6/202

References

Informative references

Attention is drawn to the following places, which may be of interest for search:

Surgical instruments for ligaturing of tubular organs, e.g. blood vessels or umbilical cord	A61B 17/12
---	----------------------------

A61F7/08

References

Informative references

Attention is drawn to the following places, which may be of interest for search:

Compresses or poultices for effecting heating or cooling	A61F 7/02
--	---------------------------

DATE: JANUARY 1, 2025

PROJECT MP12363

A61F13/38

References

Limiting references

This place does not cover:

Portable hand-held applicators having sponges, foams, absorbent pads or swabs for dispensing or spreading integral media on the human body, e.g. swabs containing a liquid in a rupturable reservoir	A61M 35/006
--	-----------------------------

Informative references

Attention is drawn to the following places, which may be of interest for search:

Ear cleaners other than cotton tips	A61F11/006
-------------------------------------	----------------------------

A61F13/505

References

Limiting references

This place does not cover:

Tampons, e.g. catamenial tampons; Accessories therefor	A61F 13/20
Reusable, washable fabric diapers	A61F 13/49003

Informative references

Attention is drawn to the following places, which may be of interest for search:

DATE: JANUARY 1, 2025

PROJECT MP12363

Supporting or fastening means	A61F 13/56
-------------------------------	----------------------------

A61F13/534

References

Limiting references

This place does not cover:

Absorbent pads characterised by specific fibre orientation or weave	A61F 13/538
Absorbent pads characterised by the connection of absorbent layers with each other or with the outer layers	A61F 13/539

Informative references

Attention is drawn to the following places, which may be of interest for search:

Homogeneous cores with tissue wrapping	A61F 13/53
--	----------------------------

A61F13/581

References

Informative references

Attention is drawn to the following places, which may be of interest for search:

Fabric strip fastener elements	A61F 13/62
--------------------------------	----------------------------

DATE: JANUARY 1, 2025

PROJECT MP12363

2. A. DEFINITIONS (modified)

A61F2/00

References

Limiting references

Delete: The following three rows from the Limiting references table:

Cosmetic articles, e.g. wigs, hair pieces	A41G 3/00, A41G 5/00
Artificial nails	A45D 31/00
Materials for prostheses	A61L 27/00

Insert: The following new Informative references section:

Informative references

Attention is drawn to the following places, which may be of interest for search:

Wigs	A41G 3/00
Hair pieces, inserts, rolls, pads, or the like; Toupées	A41G 5/00
Artificial nails	A45D 31/00
Materials for prostheses	A61L 27/00

Special rules of classification

Replace: The existing Special rules text with the following revised text:

The "subdivision" Indexing Code symbols (i.e. the non "parallel" Indexing Code symbols) are used for classifying as well the invention information as the additional information. They are stored only in the additional information field.

The "orthogonal" Indexing Code symbols are also used.

CPC NOTICE OF CHANGES 1713

DATE: JANUARY 1, 2025

PROJECT MP12363

Prostheses are classified in groups [A61F2/00](#) - [A61F2/26](#) or [A61F2/82](#) or [A61F9/00](#) or [A61F11/00](#) or subgroups thereof:

[A61F2210/00](#) Particular material properties.

[A61F2220/00](#) Fixations or connections.

[A61F2230/00](#) Geometry of prostheses.

[A61F2240/00](#) Manufacturing or designing of prostheses (specific manufacturing fields take precedence).

[A61F2250/00](#) Special features of prostheses.

A61F2/02

References

Delete: The entire Limiting references section.

Insert: The following new Informative references section:

Informative references

Attention is drawn to the following places, which may be of interest for search:

Closure means for urethra or rectum or for artificial body openings therefor	A61F 2/0004
--	-----------------------------

A61F2/04

Relationships with other classification places

Insert: A period at the end of the Relationships text as follows:

Urethral drainage stents: [A61M25/0017](#).

DATE: JANUARY 1, 2025

PROJECT MP12363

References

Limiting references

Replace: The existing Limiting references table with the following revised table:

Internal ear or nose parts, e.g. ear-drums	A61F 2/18
Larynxes; Tracheae	A61F 2/20
Instruments specially adapted for placement or removal of stents or stent-grafts	A61F 2/95

Informative references

Insert: The following table row into the existing Informative references table:

Devices, other than stent-grafts, providing patency to, or preventing collapsing of, tubular structures of the body, e.g. stents	A61F 2/82
--	---------------------------

Special rules of classification

Insert: Periods at the ends of the Special rules section paragraphs so that the entire text appears as follows:

Documents receiving a symbol in [A61F2/04](#) have to receive a further symbol information, such as:

Urinary bladders: [A61F2/042](#).

Bronchi: [A61F2002/043](#).

Oesophageal anti-reflux valves and devices: [A61F2002/044](#).

Tubes in the stomach: [A61F2002/045](#).

Trachea: [A61F2002/046](#).

Urethrae: [A61F2002/047](#).

Ureters: [A61F2002/048](#).

A61F2/062

Definition statement

Replace: The existing Definition statement text with the following revised text and new images:

Devices for creating vascular grafts by mechanical means.

Illustrative example of subject matter classified in this place:

1a.

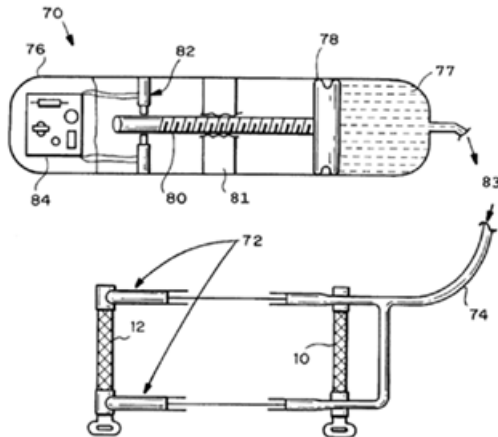

1b.

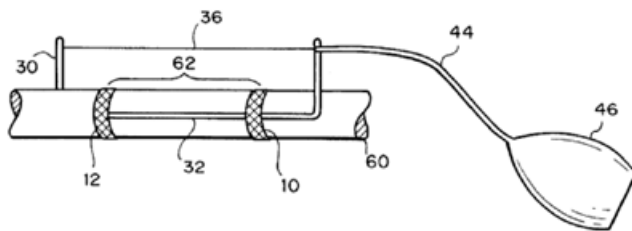

Delete: The entire Relationships with other classification places section.

References

Delete: The entire Limiting references section.

DATE: JANUARY 1, 2025

PROJECT MP12363

Insert: The following new Informative references section:

Informative references

Attention is drawn to the following places, which may be of interest for search:

Protheses made from natural tissue or living cells	A61L 27/507
Materials containing animal cells	A61L 27/38
Bioreactors for producing artificial tissue or for ex-vivo cultivation of tissue	C12M 21/08
Cell culture and products made of cells	C12N 5/00

Delete: The entire Special rules of classification section.

A61F2/08

Definition statement

Insert: A period at the end of the Definition statement text so that it appears as follows:

Artificial muscles implanted in the body.

Delete: The entire Relationships with other classification places section.

References

Delete: The entire Limiting references section.

DATE: JANUARY 1, 2025

PROJECT MP12363

Informative references

Replace: The Informative references table with the following revised table:

Sutures	A61B 17/04
Tendon anastomosis	A61B 17/1146
Operating or control means for prostheses	A61F 2/68
Prostheses not implantable in the body, e.g. muscles	A61F 2002/5066
Programme-controlled manipulators with muscles or tendons	B25J 9/1075

A61F2/12

Insert: The following new Definition statement section with images:

Definition statement

This place covers:

Illustrative examples of subject matter classified in this place:

- 1.

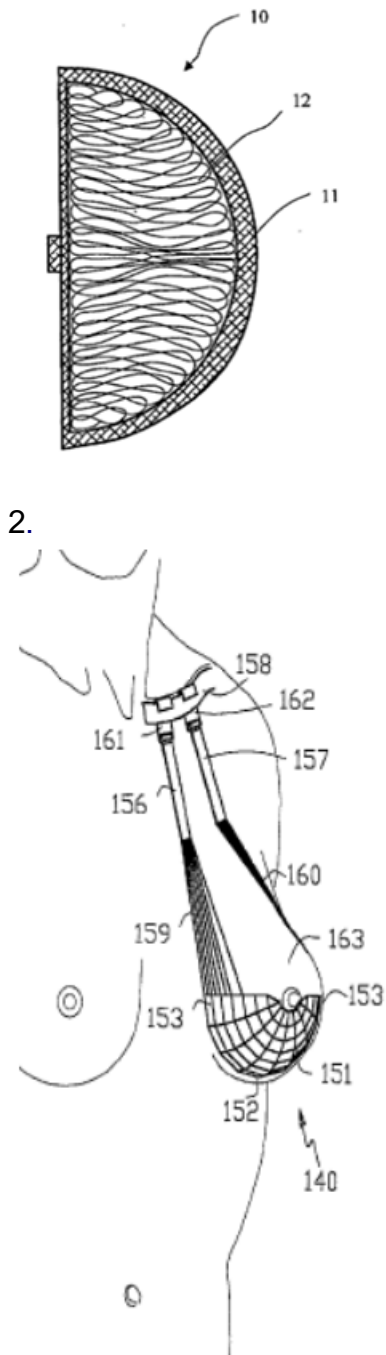

Figure 2 illustrates a mammary support implant.

DATE: JANUARY 1, 2025

PROJECT MP12363

Delete: The entire Relationships with other classification places section.

References

Delete: The entire Limiting references section.

Insert: The following new Informative references section:

Informative references

Attention is drawn to the following places, which may be of interest for search:

External mammary prostheses	A61F 2/52
Devices for expanding tissue	A61B 90/02

Delete: The entire Special rules of classification section.

A61F2/14

Definition statement

Insert: A period at the end of the Definition statement text so that it appears as follows:

All eye prostheses and replacement parts not provided for in the subclasses.

Relationships with other classification places

Replace: The Relationships section text with the following revised text:

Retinal electrodes: [A61N1/0526](#).

Retinal implants: [A61N1/36046](#).

References

Delete: The entire Limiting references section.

DATE: JANUARY 1, 2025

PROJECT MP12363

Informative references

Insert: The following three new rows into the existing Informative references table:

Shaping or joining of plastics	B29C
Making of artificial eyes from organic plastic material	B29D 11/02
Removable contact lenses	G02C 7/04

A61F2/20

Insert: The following new References/Informative references section:

References

Informative references

Attention is drawn to the following places, which may be of interest for search:

Tracheae or bronchi per se	A61F 2/04
Tracheostomy tubes	A61M 16/0465

Delete: The entire Special rules of classification section.

A61F2/2412

References

Delete: The entire Limiting references section.

Insert: The following new Informative references section:

DATE: JANUARY 1, 2025

PROJECT MP12363

Informative references

Attention is drawn to the following places, which may be of interest for search:

Check valves with flexible valve members in general	F16K 15/14
---	------------

Special rules of classification

Replace: The Special rules text with the following revised text:

Two-part valves with a docking frame into which a valve is mounted during surgery are classified in groups [A61F2/2418](#) and [A61F2250/006](#) (modular).

A61F2/28

Relationships with other classification places

Replace: The last comma in the text with “or” so that the Relationships section appears as follows:

Surgical implants which are not prosthetic, but added to the natural bone, are classified in [A61B17/00](#). Examples classified in [A61B17/00](#) are: Bone plates, bone screws, bone fixators or devices for injection of materials into bone.

References

Delete: The entire Limiting references section.

Informative references

Insert: The following new row into the existing Informative references table:

Joints	A61F 2/30
--------	-----------

Special rules of classification

Replace: The existing Special rules text with the following revised text:

Additional information is classified under [A61F2002/30001](#) and [A61F2310/00](#). Any additional information which may be useful for search must be completely classified.

A61F2/2875

Insert: The following new Definition statement section with image:

Definition statement

This place covers:

Illustrative example of subject matter classified in this place:



References

Limiting references

Replace: The existing Limiting references table with the following revised table:

Bones for mandibular reconstruction	A61F 2/2803
Joints for temporo-mandibular [TM] joints [TMJ]	A61F 2/3099

Delete: The entire Special rules of classification section.

A61F2/82

Definition statement

Replace: The Definition statement text and images with the following revised text and images.

Stents with tubular structures deployed within a stenosis in order to widen and support the vessel. The stent is usually made from a rigid material like metal or polymer.

Illustrative examples of subject matter classified in this place:

1.

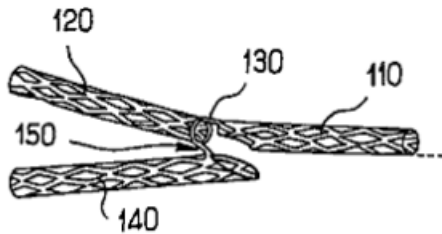

A61F2/82 (stents), A61F2002/065, A61F2002/828 (means for connecting a plurality of stents).

2.

DATE: JANUARY 1, 2025

PROJECT MP12363

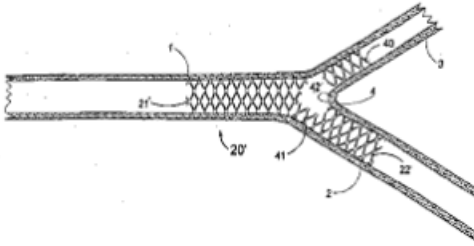

A61F2/82 (stents), A61F2002/067, A61F2002/828, A61F2/856: when it is not clear if there is a portal or if there are two stents connected, both possibilities are to be classified.

References

Limiting references

Replace: The Limiting references table with the following revised table:

Stent-grafts for tubular structures of the body other than blood vessels	A61F 2/04
Stent-grafts for blood vessels	A61F 2/07
Dilators	A61M 29/00

Insert: The following new Application-oriented references section:

Application-oriented references

Examples of places where the subject matter of this place is covered when specially adapted, used for a particular purpose, or incorporated in a larger system:

Instruments specially adapted for placement or removal of stents or stent grafts	A61F 2/95
--	-----------

DATE: JANUARY 1, 2025

PROJECT MP12363

Informative references

Replace: The Informative references table with the following revised table:

Surgical instruments, devices or methods, e.g. tourniquets, for closing wounds or holding wounds closed	A61B 17/00
Urinary catheters	A61M 25/0017

A61F2/88

References

Delete: The entire Limiting references section.

Insert: The following new Informative references section:

Informative references

Attention is drawn to the following places, which may be of interest for search:

Stents in a form characterised by a net-like or mesh-like structure	A61F 2/90
---	---------------------------

A61F2/91

Definition statement

Replace: The Definition statement text and image with the following revised text and image.

Net- or mesh-like stents made from perforated sheet material or tubes. Perforated sheet material or tubes are created by methods including, for example, laser cutting, etching or some other techniques.

Illustrative example of subject matter classified in this place:

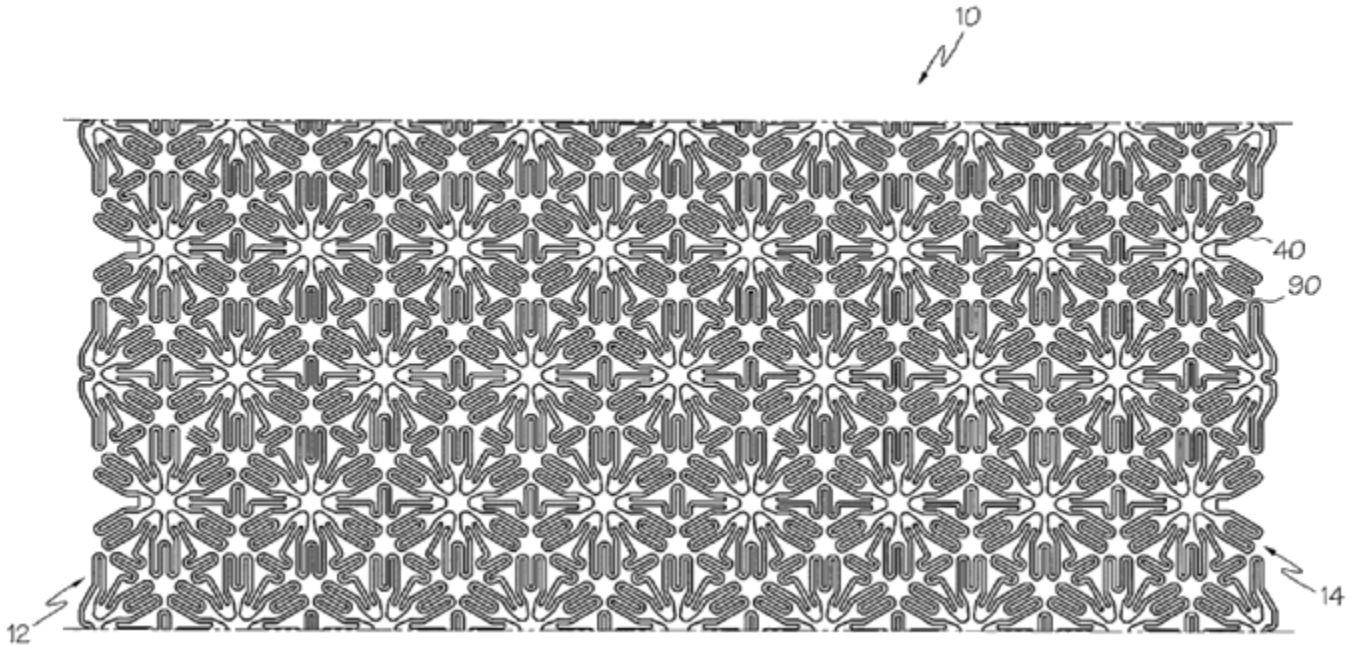

A61F4/00

Definition statement

Replace: “methods” with “Methods” so that the Definiton statement text appears as follows:

Methods or devices enabling invalids to operate a device which, otherwise, the person would not be able to, e.g. control of computers or ambulation devices like a wheel-chair.

Relationships with other classification places

Insert: Periods at the end of both Relationships section paragraphs so that the entire text appears as follows:

Chairs or personal conveyances specially adapted for disabled persons, e.g. wheelchairs: [A61G5/00](#).

Input arrangements or combined input and output arrangements for interaction between user and computer: [G06F3/01](#).

CPC NOTICE OF CHANGES 1713

DATE: JANUARY 1, 2025

PROJECT MP12363

References

Delete: The entire Limiting references section.

Informative references

Insert: The following two new rows into the existing Informative references table:

Operating or control means for prostheses implantable into the body	A61F 2/48
Operating or control means for prostheses not implantable in the body	A61F 2/68

A61F5/00

Informative references

Replace: The just the text of the below Informative references table row as shown.
The rest of the table remains unchanged.

Surgical instruments or methods for treatment of bones or joints, devices specially adapted therefor	A61B17/56
--	-----------

Delete: The entire Special rules of classification section.

DATE: JANUARY 1, 2025

PROJECT MP12363

A61F5/44

Insert: The following new Definition statement:

Definition statement

This place covers:

- Devices worn by the patients for reception of urine, faeces, catamenial or other discharge, e.g. portable urination aids.
- Colostomy devices, e.g. worn by patients for reception of discharge.

References

Limiting references

Insert: The following new row into the existing Limiting references table:

Absorbent pads, e.g. sanitary towels	A61F 13/15
--------------------------------------	----------------------------

Informative references

Delete: The following row from the Informative reference table:

Absorbent pads, e.g. sanitary towels	A61F 13/15
--------------------------------------	----------------------------

Delete: The entire Special rules of classification section.

A61F6/00

Definition statement

Replace: “contraceptive” with “Contraceptive” so that the Definition statement text appears as follows:

Contraceptive devices; pessaries and applicators therefore, which can be used by males or females, and which can be applied externally, e.g. condoms, sheaths or the like; internally, like devices worn in the vagina to support the uterus,

DATE: JANUARY 1, 2025

PROJECT MP12363

remedy a malposition, or prevent conception; as well as implantable occluding device, e.g. for vas deferens or fallopian tubes.

Relationships with other classification places

Replace: The Relationships section text with the following revised text:

Devices for promoting penis erection: [A61F5/41](#).

Massage of genitals: [A61H19/00](#).

References

Delete: The entire Limiting references section.

Informative references

Insert: The following new row into the existing Informative references table:

Chemical aspects of contraception	A61K
-----------------------------------	----------------------

Special rules of classification

Replace: The Special rules text with the following revised text:

Packages or dispensers for contraceptive devices – [A61F6/005](#).

Contraceptive devices for males, like condoms, sheaths or the like, e.g. combined with devices protecting against contagion – [A61F6/04](#).

Contraceptive device for females, like intra-vaginal or intra-uterine devices – [A61F6/08](#).

Occluders for vas deferens or fallopian tubes – [A61F6/20](#).

Note: Additional information is classified under [A61F6/00](#).

DATE: JANUARY 1, 2025

PROJECT MP12363

A61F7/00

References

Limiting references

Replace: The Limiting references table with the following revised table:

Hyperthermia using electric or magnetic fields or ultrasound	A61N
--	------

Informative references

Replace: The Informative references table with the following revised table:

Protective garments	A41D 13/00
Gloves	A41D 19/00
Hats, caps, hoods	A42B 1/00
Attachments for beds	A47C 21/00
Bed covers, blankets, pillows	A47G 9/00
Heating or cooling for surgical purposes, such as tissue removal, ablation, coagulation, etc.	A61B 18/00
Heating or cooling of tissue immediately around tissue treated by a surgical probe	A61B 2018/00005
Massage and therapeutic baths	A61H 1/00
Temperature treatment of blood in bypass of the human or animal body	A61M 1/369
Heating or cooling media before injection into the body	A61M 5/44
Heating for divers	B63C 11/28
Materials for the production of heat or cold by chemical reaction	C09K 5/00
Compression machines, plants or systems with non-reversible cycle	F25B 1/00

CPC NOTICE OF CHANGES 1713

DATE: JANUARY 1, 2025

PROJECT MP12363

Producing ice	F25C 1/00
Devices using naturally cold air or cold water	F25D 1/00
Electric heating devices	H05B 1/00

Special rules of classification

Replace: “equipments” with “equipment” in the second paragraph under the “Further details of subgroups” subheading as follows:

[A61F7/0053](#): Cabins, rooms chairs or other equipment for treatment with a hot or cold circulating fluid. Does not cover heating pads with a circulating fluid, those are to be classified in [A61F7/02](#).

Glossary of terms

Replace: The Glossary of terms table with the following revised table:

hyperthermia	heating of tissue up to but not beyond the point of tissue damage
hypothermia	cooling of tissue down to but not beyond the point of tissue damage

A61F9/00

References

Limiting references

Replace: The Limiting references table with the following revised table:

Caps with means for protecting the eyes	A42B 1/0181
Visors for helmets	A42B 3/22
Eye baths	A61H 35/02
Sunglasses or goggles having the same features as spectacles	G02C

DATE: JANUARY 1, 2025

PROJECT MP12363

Insert: The following new Informative references section:

Informative references

Attention is drawn to the following places, which may be of interest for search:

Retractors	A61B 17/02
Manipulators specially adapted for use in surgery	A61B 34/70
Appliances for aiding patients or disabled persons to walk	A61H 3/00
Exercisers for the eyes	A61H 5/00

Special rules of classification

Replace: The parenthesis with a period at the end of the first paragraph so the entire Special rules section appears as follows:

The "subdivision" Indexing Code symbols (i.e. the non "parallel" Indexing Code symbols) are used for classifying as well the invention information as the additional information. They are stored only in the additional information field.

The "orthogonal" Indexing Code symbols are also used.

The symbols in [A61B17/00](#) and [A61B18/00](#) are to be used for classifying additional information in case there is no appropriate symbol in [A61F9/00736](#), [A61F9/0079](#) or [A61F9/008](#).

[A61F9/02](#)

References

Limiting references

Replace: The Limiting references table with the following revised table:

Swimming goggles	A63B 33/00
------------------	----------------------------

CPC NOTICE OF CHANGES 1713

DATE: JANUARY 1, 2025

PROJECT MP12363

Insert: The following new Informative references section:

Informative references

Attention is drawn to the following places, which may be of interest for search:

Breathing masks	A62B 18/00
Diving masks	B63C 11/12

A61F9/04

Definition statement

Replace: The Definition statement text and image with the following revised text and image:

Sleep masks.

Masks for protecting the eye after ophthalmic surgery.

Illustrative example of subject matter classified in this place:

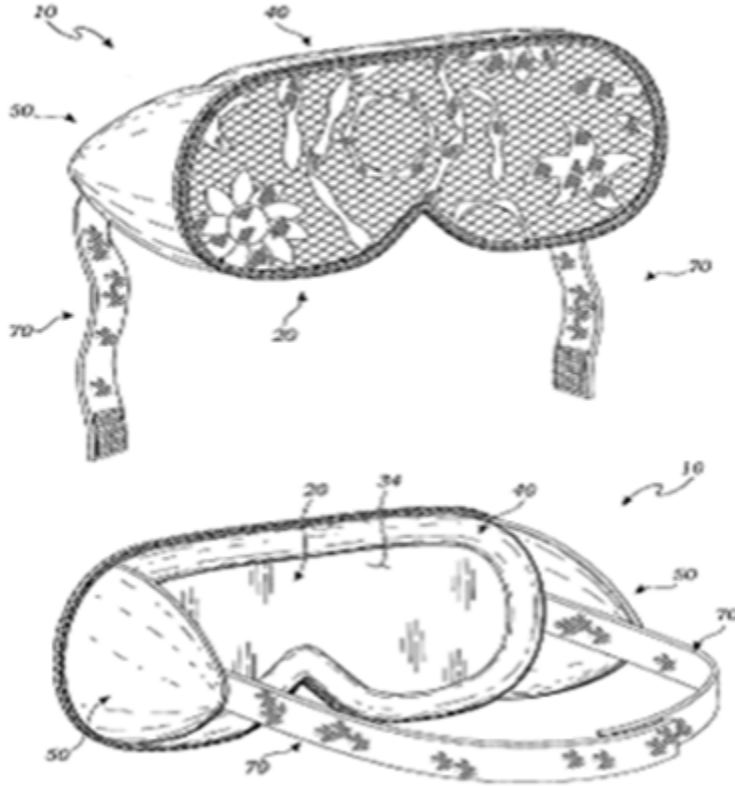

References

Delete: The entire Limiting references section.

Insert: The following new Informative references section:

Informative references

Attention is drawn to the following places, which may be of interest for search:

Eye-bandages	A61F 13/12
Protective face-masks	A41D 13/11
Protectors for shampooing	A45D

DATE: JANUARY 1, 2025

PROJECT MP12363

A61F9/06

References

Delete: The entire Limiting references section.

Insert: The following new Informative references section:

Informative references

Attention is drawn to the following places, which may be of interest for search:

Safety devices for welding in general	F16P1/00
---------------------------------------	--------------------------

A61F11/00

References

Limiting references

Delete: The symbol A42B 3/16 from the below Limiting references table row so that the table row appears as shown. The rest of the table remains unchanged.

Headwear, e.g. caps or helmets, with means for protecting the ears	A42B 1/0188
--	-----------------------------

Glossary of terms

Replace: The Glossary of terms table with the following revised table:

auditory perception	the ability to detect and interpret sounds
hearing sense	the ability to perceive sounds by detecting vibrations or changes in the pressure of the surrounding medium through time using the auditory parts of the sensory system

DATE: JANUARY 1, 2025

PROJECT MP12363

A61F13/02

References

Informative references

Replace: The Informative references table with the following revised table:

Bandages or dressings specially adapted for feet or legs; Corn-pads; Corn-rings	A61F 13/06
Elastic stockings; For contracting aneurisms	A61F 13/08
Bandages or dressings specially adapted for fingers, hands or arms; Finger-stalls; Nail-protectors	A61F 13/10
Bandages or dressings specially adapted for the head or neck	A61F 13/12
Bandages or dressings specially adapted for the breast or abdomen	A61F 13/14
Absorbent pads, e.g. sanitary towels, swabs or tampons for external or internal application to the body; Supporting or fastening means therefor; Tampon applicators	A61F 13/15
Vaccination diagnosis other than by injuring the skin, e.g. allergy test patches	A61B 10/0035
Surgical adhesives or cements; Adhesives for colostomy devices	A61L 24/00
Devices for applying media, e.g. remedies, on the human body	A61M 35/00

DATE: JANUARY 1, 2025

PROJECT MP12363

A61F13/04**References**Insert: The following new Limiting references table:***Limiting references****This place does not cover:*

Orthopaedic devices, e.g. long-term immobilising or pressure directing devices for treating broken or deformed bones such as splints, casts or braces	A61F 5/01
Bandages, dressings or absorbent pads specially adapted for feet or legs; Corn-pads; Corn-rings	A61F 13/06
Bandages, dressings or absorbent pads specially adapted for fingers, hands or arms; Finger-stalls; Nail-protectors	A61F 13/10
Bandages, dressings or absorbent pads specially adapted for the head or neck	A61F 13/12
Bandages, dressings or absorbent pads specially adapted for the breast or abdomen	A61F 13/14
Absorbent pads, e.g. sanitary towels, swabs or tampons for external or internal application to the body	A61F 13/15

Informative referencesReplace: The Informative references table with the following revised table:

Chemical aspects of orthopaedic devices	A61L 15/07
---	------------

DATE: JANUARY 1, 2025

PROJECT MP12363

A61F13/10

References

Informative references

Replace: The Informative references table with the following revised table:

Orthopaedic methods or devices for non-surgical treatment of bones or joints	A61F 5/00
Orthopaedic devices for the arms, hands or fingers	A61F 5/0118
Restraining devices for arms	A61F 5/37
Slings	A61F 5/3738
Shoulder bandages	A61F 13/14

A61F13/15

References

Application-oriented references

Replace: The Application-oriented references table with the following revised table:

Articles for absorbing wound excretions	A61F 13/00
Adhesive bandages or dressings	A61F 13/02
Bandages or dressings specially adapted for absorbing wound excretions for feet or legs	A61F 13/06
Bandages or dressings specially adapted for absorbing wound excretions for fingers, hands or arms	A61F 13/10

CPC NOTICE OF CHANGES 1713

DATE: JANUARY 1, 2025

PROJECT MP12363

Bandages or dressings specially adapted for absorbing wound excretions for head or neck	A61F 13/12
Bandages or dressings specially adapted for absorbing wound excretions for breast or abdomen	A61F 13/14

Informative references

Replace: The Informative references table with the following revised table:

Underwear	A41B 9/00
Wristbands or headbands, e.g. for absorbing sweat	A41D 20/00
Fittings or trimmings for hats, e.g. hat-bands	A42C 5/00
Insoles for insertion, e.g. footbeds or inlays	A43B 17/00
Non-absorbent catamenial devices	A61F 5/44
Pessaries	A61F 6/08
Tissues, wipes or patches for cleaning the skin (e.g. wet wipes)	A61K 8/0208

Delete: The entire Special rules of classification section.

A61F13/476

Definition statement

Replace: The Definition statement text with the following revised text:

Articles of the feminine hygiene napkin type having wings or flaps for being wrapped over the edge of the underwear. The primary function of the flaps should be the prevention of leakage or soiling the undergarment.

References

CPC NOTICE OF CHANGES 1713

DATE: JANUARY 1, 2025

PROJECT MP12363

Delete: The entire Limiting references section.

Insert: The following new Informative references section:

Informative references

Attention is drawn to the following places, which may be of interest for search:

Supporting means specially adapted for fastening the article on the underwear	A61F 13/5605
---	------------------------------

A61F13/51

Insert: The following new References/Limiting references/Informative references sections:

References

Limiting references

This place does not cover:

Tampons	A61F 13/20
---------	----------------------------

Informative references

Attention is drawn to the following places, which may be of interest for search:

Wicking or transfer layers	A61F 13/537
----------------------------	-----------------------------

A61F13/62

Relationships with other classification places

Insert: A period at the end of the Relationships section text as shown:
Hook and loop in general and the manufacturing thereof: [A44B18/00](#).

DATE: JANUARY 1, 2025

PROJECT MP12363

Insert: The following new References/Limiting references sections.

References

Limiting references

This place does not cover:

Support using fastening strips	A61F 13/5611
Support using flaps	A61F 13/5616
Tab fastener elements combining adhesive and mechanical fastening	A61F 13/581
Garments, holders or supports not integral with absorbent pads	A61F 13/66

A61F15/00

References

Limiting references

Replace: The Limiting references table with the following revised table:

Packaging of wound dressings	A61F 13/00072
------------------------------	-------------------------------

Insert: The following new Informative references section:

Informative references

Attention is drawn to the following places, which may be of interest for search:

Individual wrapped articles before or after use	A61F 13/551
---	-----------------------------