

EUROPEAN PATENT OFFICE
U.S. PATENT AND TRADEMARK OFFICE

CPC NOTICE OF CHANGES 1657

DATE: JANUARY 1, 2025

PROJECT RP10469

The following classification changes will be effected by this Notice of Changes:

<u>Action</u>	<u>Subclass</u>	<u>Group(s)</u>
SCHEME:		
Symbols Deleted:	A45C	2011/001, 2011/002, 2011/003
	A45F	2003/166
	A45F	2200/00, 2200/05, 2200/0508, 2200/0516, 2200/0525, 2200/0533, 2200/0541, 2200/055, 2200/0558, 2200/0566, 2200/0575, 2200/0583, 2200/0591
Symbols Deleted Pending Reclassification: (frozen (F))	G06F	2200/1633
Symbols New:	A45C	11/001, 11/002, 11/003
	A45F	3/166
	A45F	5/1508, 5/1516, 5/1525, 5/1533, 5/1541, 5/155, 5/1558, 5/1566, 5/1575, 5/1583, 5/1588
	G06F	1/1629
	H04M	1/0203
Titles Changed:	A45F	5/14
	G06F	1/1628
	H04M	1/185
Warnings New:	A45C	11/00, 11/001, 11/002, 11/003
	A45F	3/166
	A45F	5/1516, 5/1588
	G06F	1/1613, 1/1628, 1/1629, 1/1656
	G06F	2200/1633
	H04B	2001/3855, 2001/3861, 1/3888
	H04M	1/0203, 1/18, 1/185
DEFINITIONS:		
Definitions New:	A45C	11/001, 11/002, 11/003
	A45F	5/1508, 5/1516, 5/1525, 5/1533, 5/1588,
	G06F	1/1629
	H04B	1/385, 1/3888
	H04M	1/0203, 1/185
Definitions Modified:	A45C	11/00, 11/22, 11/38,
	A45F	3/16
	A45F	4/02
	A45F	5/00, 5/14
	G06F	1/1613, 1/1628, 1/163, 1/1656
	H04M	1/04, 1/17, 1/18

The following subclasses/groups are also impacted by this Notice of Changes (indicate subclasses/groups outside of the project scope, such as those listed in the CRL): A44B 15/005

This Notice of Changes includes the following [Check the ones included]:

1. CLASSIFICATION SCHEME CHANGES

CPC NOTICE OF CHANGES 1657

DATE: JANUARY 1, 2025

PROJECT RP10469

- A. New, Modified or Deleted Group(s)
- B. New, Modified or Deleted Warning(s)
- C. New, Modified or Deleted Note(s)
- D. New, Modified or Deleted Guidance Heading(s)

2. DEFINITIONS

- A. New or Modified Definitions (Full definition template)
- B. Modified or Deleted Definitions (Definitions Quick Fix)

3. REVISION CONCORDANCE LIST (RCL)

4. CHANGES TO THE CPC-TO-IPC CONCORDANCE LIST (CICL)

5. CHANGES TO THE CROSS-REFERENCE LIST (CRL)

CPC NOTICE OF CHANGES 1657

DATE: JANUARY 1, 2025

PROJECT RP10469

1. CLASSIFICATION SCHEME CHANGES

A. New, Modified or Deleted Group(s)

SUBCLASS A45C - PURSES; LUGGAGE; HAND CARRIED BAGS

<u>Type*</u>	<u>Symbol</u>	<u>Indent Level</u> <u>Number of</u> <u>dots (e.g. 0,</u> <u>1, 2)</u>	<u>Title</u> <u>“CPC only” text should normally be</u> <u>enclosed in {curly brackets}**</u>	<u>Transferred to#</u>
C	A45C 11/00	0	Receptacles for purposes not provided for in groups A45C 1/00-A45C 9/00 (specially adapted for toiletry or cosmetic equipment A45D 29/20, A45D 44/18; travelling sewing kits A45F 3/48)	A45C 11/00, A45C 11/001, A45C 11/002, A45C 11/003, G06F 1/1629, H04M 1/0203
D	A45C 2011/001	1	{for portable audio devices, e.g. headphones or MP3-players}	<administrative transfer to A45C 11/001 INV>
Q	A45C 11/001	1	{for storing portable audio devices, e.g. headphones or digital music players}	A45C 11/001, G06F 1/1629, H04M 1/0203
D	A45C 2011/002	1	{for portable handheld communication devices, e.g. mobile phone, pager, beeper, PDA, smart phone}	<administrative transfer to A45C 11/002 INV>
Q	A45C 11/002	1	{for storing portable handheld communication devices, e.g. pagers or smart phones}	A45C 11/002, H04M 1/0203
D	A45C 2011/003	1	{for portable computing devices, e.g. laptop, tablet, netbook, game boy, navigation system, calculator}	<administrative transfer to A45C 11/003 INV>
Q	A45C 11/003	1	{for storing portable computing devices, e.g. laptops, tablets or calculators}	A45C 11/003, G06F 1/1629, G06F 1/1656

SUBCLASS A45F - TRAVELLING OR CAMP EQUIPMENT: SACKS OR PACKS CARRIED ON THE BODY

<u>Type*</u>	<u>Symbol</u>	<u>Indent Level</u> <u>Number of dots</u> <u>(e.g. 0, 1, 2)</u>	<u>Title</u> <u>“CPC only” text should normally be</u> <u>enclosed in {curly brackets}**</u>	<u>Transferred to#</u>
U	A45F 2003/163	2	{Water bottles with purification filter}	
D	A45F 2003/166	2	{Hydration systems attached to the body by straps, e.g. incorporated in a backpack}	<administrative transfer to A45F3/166 INV>
Q	A45F 3/166	2	{Hydration systems incorporated in a backpack}	A45F3/166, A45F5/1588
M	A45F 5/14	1	Holders for spades, hatchets or the like implements	
N	A45F 5/1508	1	{Holders or carriers for portable audio devices, e.g. headphones or digital music players}	
N	A45F 5/1516	1	{Holders or carriers for portable handheld communication devices, e.g. pagers or smart phones}	

CPC NOTICE OF CHANGES 1657

DATE: JANUARY 1, 2025

PROJECT RP10469

N	A45F5/1525	1	{Holders or carriers for portable computing devices, e.g. laptops, tablets or calculators }	
N	A45F5/1533	1	{Holders or carriers for cameras }	
N	A45F5/1541	1	{Holders or carriers for eyeglasses or spectacles }	
N	A45F5/155	1	{Holders or carriers for thin, flat, rectangular articles, e.g. ID badges or cards }	
N	A45F5/1558	1	{Holders or carriers for keys }	
N	A45F5/1566	1	{Holders or carriers for tubular, rod-shaped articles, e.g. batons }	
N	A45F5/1575	1	{Holders or carriers for portable tools }	
N	A45F5/1583	1	{Holders or carriers for beverage vessels, e.g. bottles }	
N	A45F5/1588	2	{for hydration systems, e.g. bladder with drinking tube }	
D	A45F2200/00	0	Details not otherwise provided for in A45F	<no transfer>
D	A45F2200/05	1	Holder or carrier for specific articles	<no transfer>
D	A45F2200/0508	2	Portable audio devices, e.g. walkman, discman, radio, MP3 player, headphones	<administrative transfer to A45F5/1508 INV>
D	A45F2200/0516	2	Portable handheld communication devices, e.g. mobile phone, pager, beeper, PDA, smart phone	<administrative transfer to A45F5/1516 INV>
D	A45F2200/0525	2	Personal portable computing devices, e.g. laptop, tablet, netbook, game boy, navigation system, calculator	<administrative transfer to A45F5/1525 INV>
D	A45F2200/0533	2	Cameras, e.g. reflex, digital, video camera	<administrative transfer to A45F5/1533 INV>
D	A45F2200/0541	2	Eyeglasses or spectacles	<administrative transfer to A45F5/1541 INV>
D	A45F2200/055	2	Thin, flat, rectangular articles, e.g. ID badges or cards	<administrative transfer to A45F5/155 INV>
D	A45F2200/0558	2	Keys	<administrative transfer to A45F5/1558 INV>
D	A45F2200/0566	2	Tubular, rod-shaped articles, e.g. batons	<administrative transfer to A45F5/1566 INV>
D	A45F2200/0575	2	Portable tools	<administrative transfer to A45F5/1575 INV>
D	A45F2200/0583	2	Beverage vessels, e.g. bottles	<administrative transfer to A45F5/1583 INV>
D	A45F2200/0591	2	Defense articles, e.g. small arms, handguns, pistols, or the like	<no transfer>

CPC NOTICE OF CHANGES 1657

DATE: JANUARY 1, 2025

PROJECT RP10469

SUBCLASS G06F - ELECTRIC DIGITAL DATA PROCESSING

<u>Type*</u>	<u>Symbol</u>	<u>Indent Level</u> <u>Number of dots (e.g. 0, 1, 2)</u>	<u>Title</u> <u>“CPC only” text should normally be enclosed in {curly brackets}**</u>	<u>Transferred to#</u>
C	G06F 1/1613	2	{for portable computers (cooling arrangements therefor G06F1/203; constructional details or arrangements for pocket calculators, electronic agendas or books G06F15/0216; constructional details of portable telephone sets: with several bodies H04M1/0202)}	G06F1/1613, G06F1/1629
C	G06F 1/1628	3	{Enclosures for carrying portable computers with peripheral devices, e.g. cases for a laptop and a printer}	G06F1/1628, A45C11/003, G06F1/1629
N	G06F 1/1629	3	{Protective covers or auxiliary enclosures for portable computers (for carrying with peripheral devices G06F1/1628; for storing A45C11/003)}	
F	G06F 2200/1633	3	Protecting arrangement for the entire housing of the computer	A45C11/003, G06F1/1629, G06F1/1656, H04M1/0203

SUBCLASS H04B – TRANSMISSION

<u>Type*</u>	<u>Symbol</u>	<u>Indent Level</u> <u>Number of dots (e.g. 0, 1, 2)</u>	<u>Title</u> <u>“CPC only” text should normally be enclosed in {curly brackets}**</u>	<u>Transferred to#</u>
C	H04B 2001/3855	4	{carried in a belt or harness}	H04B2001/3855, A45F5/1516
C	H04B 2001/3861	4	{carried in a hand or on fingers}	H04B 2001/3861, A45F5/1516
C	H04B 1/3888	3	Arrangements for carrying or protecting transceivers	H04B 1/3888, A45C11/002, A45C11/003, G06F1/1629, H04M1/0203

CPC NOTICE OF CHANGES 1657

DATE: JANUARY 1, 2025

PROJECT RP10469

SUBCLASS H04M - TELEPHONIC COMMUNICATION

Type*	Symbol	Indent Level Number of dots (e.g. 0, 1, 2)	Title “CPC only” text should normally be enclosed in {curly brackets}**	Transferred to#
U	H04M 1/0202	2	{Portable telephone sets, e.g. cordless phones, mobile phones or bar type handsets (constructional features of telephone transmitters or receivers, e.g. of speakers or microphones H04M 1/03)}	
N	H04M 1/0203	3	{Protective covers or auxiliary enclosures for portable telephones (for storing A45C11/002)}	
C	H04M 1/18	2	Telephone sets specially adapted for use in ships, mines, or other places exposed to adverse environment (H04M1/19 takes precedence)	H04M1/18, H04M1/0203
C	H04M 1/185	3	{Improving the shock resistance of the housing, e.g. by increasing the rigidity }	H04M1/185, H04M1/0203, H04M1/18

*N = new entries where reclassification into entries is involved; C = entries with modified file scope where reclassification of documents from the entries is involved; Q = new entries which are firstly populated with documents via administrative transfers from deleted (D) entries. Afterwards, the transferred documents into the Q entry will either stay or be moved to more appropriate entries, as determined by intellectual reclassification; T = existing entries with enlarged file scope, which receive documents from C or D entries, e.g. when a limiting reference is removed from the entry title; M = entries with no change to the file scope (no reclassification); D = deleted entries; F = frozen entries will be deleted once reclassification of documents from the entries is completed; U = entries that are unchanged.

NOTES:

- **No {curly brackets } are used for titles in CPC only subclasses, e.g. C12Y, A23Y; 2000 series symbol titles of groups found at the end of schemes (orthogonal codes); or the Y section titles. The {curly brackets } are used for 2000 series symbol titles found interspersed throughout the main trunk schemes (breakdown codes).
- U groups: it is obligatory to display the required “anchor” symbol (U group), i.e. the entry immediately preceding a new group or an array of new groups to be created (in case new groups are not clearly subgroups of C-type groups). Always include the symbol, Indent Level and title of the U group in the table above.
- All entry types should be included in the scheme changes table above for better understanding of the overall scheme change picture. Symbol, Indent Level, and title are required for all types.
- “Transferred to” column must be completed for all C, D, F, and Q type entries. F groups will be deleted once reclassification is completed.
- When multiple symbols are included in the “Transferred to” column, avoid using ranges of symbols in order to be as precise as possible.
- For administrative transfer of documents, the following text should be used: “<administrative transfer to XX>”, “<administrative transfer to XX and YY simultaneously>”, or “<administrative transfer to XX, YY, ...and ZZ simultaneously>” when administrative transfer of the same documents is to more than one place.
- Administrative transfer to main trunk groups is assumed to be the source allocation type, unless otherwise indicated.
- Administrative transfer to 2000/Y series groups is assumed to be “additional information”.
- If needed, instructions for allocation type should be indicated within the angle brackets using the abbreviations “ADD” or “INV”: <administrative transfer to XX ADD> , <administrative transfer to XX INV>, or <administrative transfer to XX ADD, YY INV, ... and ZZ ADD simultaneously>.
- In certain situations, the “D” entries of 2000-series or Y-series groups may not require a destination (“Transferred to”) symbol, however it is required to specify “<no transfer>” in the “Transferred to” column for such cases.
- For finalization projects, the deleted “F” symbols should have <no transfer> in the “Transferred to” column.
- For more details about the types of scheme change, see CPC Guide.

CPC NOTICE OF CHANGES 1657

DATE: JANUARY 1, 2025

PROJECT RP10469

B. New, Modified or Deleted Warning notice(s)

SUBCLASS A45C, A45F, H04B, H04M

Type	Location	Old warning	New warning
N	A45C 11/00		Group A45C 11/00 is impacted by reclassification into groups A45C 11/001, A45C 11/002, A45C 11/003, G06F 1/1629 and H04M 1/0203. All groups listed in this Warning should be considered in order to perform a complete search.
N	A45C 11/001		Group A45C 11/001 is incomplete pending reclassification of documents from group A45C 11/00. Group A45C 11/001 is also impacted by reclassification into groups G06F 1/1629 and H04M 1/0203. All groups listed in this Warning should be considered in order to perform a complete search.
N	A45C 11/002		Group A45C 11/002 is incomplete pending reclassification of documents from groups A45C 11/00 and H04B 1/3888. Group A45C 11/002 is also impacted by reclassification into group H04M 1/0203. All groups listed in this Warning should be considered in order to perform a complete search.
N	A45C 11/003		Group A45C 11/003 is incomplete pending reclassification of documents from groups A45C 11/00, G06F 1/1628, G06F 2200/1633 and H04B 1/3888. Group A45C 11/003 is also impacted by reclassification into groups G06F 1/1629 and G06F 1/1656. All groups listed in this Warning should be considered in order to perform a complete search.
N	A45F 3/166		Group A45F 3/166 is impacted by reclassification into group A45F 5/1588. Groups A45F 3/166 and A45F 5/1588 should be considered in order to perform a complete search.
N	A45F 5/1516		Group A45F 5/1516 is incomplete pending reclassification of documents from groups H04B 2001/3855 and H04B 2001/3861. Groups H04B 2001/3855, H04B 2001/3861 and A45F 5/1516 should be considered in order to perform a complete search.
N	A45F 5/1588		Group A45F 5/1588 is incomplete pending reclassification of documents from group A45F 3/166. Groups A45F 3/166 and A45F 5/1588 should be considered in order to perform a complete search.
N	G06F 1/1613		Group G06F 1/1613 is impacted by reclassification into group G06F 1/1629. Groups G06F 1/1613 and G06F 1/1629 should be considered in order to perform a complete search.
N	G06F 1/1628		Group G06F 1/1628 is impacted by reclassification into groups A45C 11/003 and G06F 1/1629. Groups G06F 1/1628, A45C 11/003 and G06F 1/1629 should be considered in order to perform a complete search.
N	G06F 1/1629		Group G06F 1/1629 is incomplete pending reclassification of documents from groups A45C 11/00, A45C 11/001, A45C 11/003, G06F 1/1613, G06F 1/1628, G06F 2200/1633 and H04B 1/3888. All groups listed in this Warning should be considered in order to perform a complete search.
N	G06F 1/1656		Group G06F 1/1656 is incomplete pending reclassification of documents from groups A45C 11/003 and G06F 2200/1633. Groups A45C 11/003, G06F 2200/1633 and G06F 1/1656 should be considered in order to perform a complete search.

CPC NOTICE OF CHANGES 1657

DATE: JANUARY 1, 2025

PROJECT RP10469

N	G06F 2200/1633		Group G06F 2200/1633 is no longer used for the classification of documents as of January 1, 2025. The content of this group is being reclassified into groups A45C 11/003, G06F 1/1629, G06F 1/1656 and H04M 1/0203. All groups listed in this Warning should be considered in order to perform a complete search.
N	H04B 2001/3855		Group H04B 2001/3855 is impacted by reclassification into group A45F 5/1516. Groups H04B 2001/3855 and A45F 5/1516 should be considered in order to perform a complete search.
N	H04B 2001/3861		Group H04B 2001/3861 is impacted by reclassification into group A45F 5/1516. Groups H04B 2001/3861 and A45F 5/1516 should be considered in order to perform a complete search.
N	H04B 1/3888		Group H04B 1/3888 is impacted by reclassification into groups A45C 11/002, A45C 11/003, G06F 1/1629 and H04M 1/0203. All groups listed in this Warning should be considered in order to perform a complete search.
N	H04M 1/0203		Group H04M 1/0203 is incomplete pending reclassification of documents from groups A45C 11/00, A45C 11/001, A45C 11/002, G06F 2200/1633, H04B 1/3888, H04M 1/18 and H04M 1/185. All groups listed in this Warning should be considered in order to perform a complete search.
N	H04M 1/18		Group H04M 1/18 is incomplete pending reclassification of documents from group H04M 1/185. Group H04M 1/18 is also impacted by reclassification into group H04M 1/0203. Groups H04M 1/18, H04M 1/185 and H04M 1/0203 should be considered in order to perform a complete search.
N	H04M 1/185		Group H04M 1/185 is impacted by reclassification into groups H04M 1/0203 and H04M 1/18. Groups H04M 1/185, H04M 1/0203 and H04M 1/18 should be considered in order to perform a complete search.

*N = new warning, M = modified warning, D = deleted warning

NOTE: The "Location" column only requires the symbol PRIOR to the location of the warning. No further directions such as "before" or "after" are required.

2. A. DEFINITIONS (new)

A45C11/001

Definition statement

This place covers:

Receptacles for storing portable audio devices like headphones or digital audio players. The audio device is intended to be removed from the storage receptacle for its use.

Relationships with other classification places

Receptacles for storing of portable audio devices like headphones or digital audio are classified in [A45C 11/001](#) while holders or carriers being worn by a user for portable audio devices, portable handheld communication devices and portable computing devices to facilitate transporting or carrying, where the device is not in use or being passively used, are classified in groups [A45F 5/1508](#), [A45F 5/1516](#) and [A45F5/1525](#), respectively.

Protective covers or auxiliary enclosures for portable computers that are intended to hold the device during use without hampering said use are classified in [G06F 1/1629](#).

Protective covers or auxiliary enclosures for mobile phones that are intended to hold the device during use without hampering the telephonic functions are classified in [H04M 1/0203](#).

Constructional features, like venting or EMI shielding means, of electronic housings not characterised by the inner electronic arrangements are classified in [H05K 5/00](#).

Supports for positioning or steadying a device relative to a person with the intent of using the device are classified in [F16M 13/04](#).

DATE: JANUARY 1, 2025

PROJECT RP10469

References***Informative references****Attention is drawn to the following places, which may be of interest for search:*

Holders or carriers for portable audio devices	A45F 5/1508
Holders or carriers for portable handheld communication devices	A45F 5/1516
Holders or carriers for portable computing devices	A45F 5/1525
Enclosures for carrying portable computers with peripheral devices	G06F 1/1628
Protective covers or auxiliary enclosures for portable computers	G06F 1/1629
Arrangements for carrying or protecting portable transceivers	H04B 1/3888
Protective covers or auxiliary enclosures for portable telephones	H04M 1/0203
Casings, cabinets or drawers for electric apparatus	H05K 5/00

Special rules of classification

If the device is a mobile phone that also has digital audio playing capabilities, it should only be classified in portable handheld communication devices [A45C 11/002](#).

If the device is a computer or tablet that also has digital audio playing capabilities, it should only be classified in portable computing devices [A45C 11/003](#).

Glossary of terms*In this place, the following terms or expressions are used with the meaning indicated:*

storing	to put or keep something in a receptacle for future use
---------	---

[A45C11/002](#)**Definition statement***This place covers:*

Receptacles for storing portable handheld communication devices, e.g. mobile phones, pagers, beepers, personal digital assistants or smart phones. The communication device is intended to be removed from the storage receptacle for its use.

Illustrative examples of subject matter classified in this place:

1.

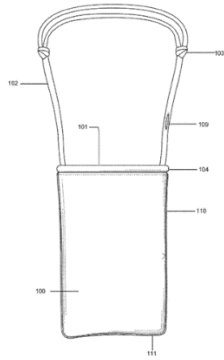

2.

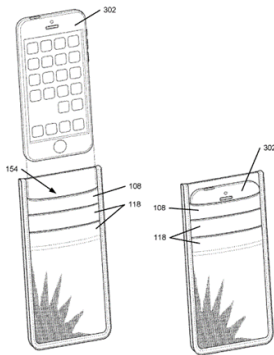

Relationships with other classification places

Receptacles for storing of portable handheld communication devices are classified in [A45C 11/002](#) while holders or carriers being worn by a user for portable audio devices, portable handheld communication devices and portable computing devices to facilitate transporting or carrying, where the device is not in use or being passively used, are classified in groups [A45F 5/1508](#), [A45F 5/1516](#) and [A45F 5/1525](#), respectively.

In addition, protective covers or auxiliary enclosures for portable computers that are intended to hold the device during use without hampering said use are classified in [G06F 1/1629](#).

DATE: JANUARY 1, 2025

PROJECT RP10469

Protective covers or auxiliary enclosures for mobile phones that are intended to hold the device during use without hampering the telephonic functions are classified in [H04M 1/0203](#).

Constructional features, like venting or EMI shielding means, of electronic housings not characterised by the inner electronic arrangements are classified in [H05K 5/00](#).

Supports for positioning or steadying a device relative to a person with the intent of using the device are classified in [F16M 13/04](#).

References

Informative references

Attention is drawn to the following places, which may be of interest for search:

Holders or carriers for portable audio devices	A45F 5/1508
Holders or carriers for portable handheld communication devices	A45F 5/1516
Holders or carriers for portable computing devices	A45F 5/1525
Supports for positioning or steadying a device relative to a person	F16M 13/04
Enclosures for carrying portable computers with additional elements	G06F 1/1628
Protective covers or auxiliary enclosures for portable computers	G06F 1/1629
Arrangements for carrying or protecting portable transceivers	H04B 1/3888
Protective covers or auxiliary enclosures for portable telephones	H04M 1/0203
Casings, cabinets or drawers for electric apparatus	H05K 5/00

Special rules of classification

If the device is a mobile phone that also has digital audio playing capabilities and/or computing capabilities, it should only be classified in receptacles for portable handheld communication devices [A45C 11/002](#).

If the device is a computer or tablet that also has digital audio playing capabilities and/or communication capabilities, it should only be classified in receptacles for portable computing devices [A45C 11/003](#).

Glossary of terms

In this place, the following terms or expressions are used with the meaning indicated:

storing	to put or keep something in a receptacle for future use
---------	---

A45C11/003

Definition statement

This place covers:

Receptacles for storing portable computing devices, e.g. laptops, tablets, netbooks, potable gaming device, navigation systems or calculators. The computing device is intended to be removed from the storage receptacle for its use.

Illustrative examples of subject matter classified in this place:

1.



Figure 1 illustrates a laptop sleeve.

2.

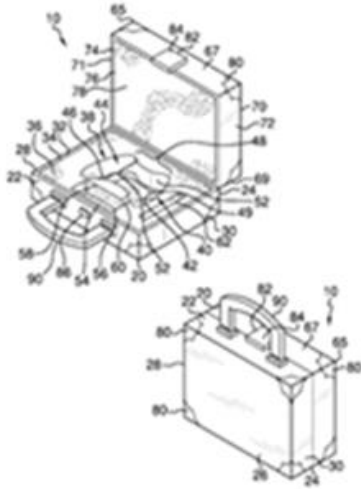

Figure 2 illustrates how a receptacle stores a video game controller.

Relationships with other classification places

Receptacles for storing of portable handheld computing devices are classified in [A45C 11/003](#) while holders or carriers being worn by a user for portable audio devices, portable handheld communication devices and portable computing devices to facilitate transporting or carrying, where the device is not in use or being passively used, are classified in groups [A45F 5/1508](#), [A45F 5/1516](#) and [A45F5/1525](#), respectively.

Protective covers or auxiliary enclosures for portable computers that are intended to hold the device during use without hampering said use are classified in [G06F 1/1629](#).

Protective covers or auxiliary enclosures for mobile phones that are intended to hold the device during use without hampering the telephonic functions are classified in [H04M 1/0203](#).

Constructional features, like venting or EMI shielding means, of electronic housings not characterised by the inner electronic arrangements are classified in [H05K 5/00](#).

Supports for positioning or steadying a device relative to a person with the intent of using the device are classified in [F16M 13/04](#).

DATE: JANUARY 1, 2025

PROJECT RP10469

References**References out of a residual place***Examples of places in relation to which this place is residual:*

Briefcases, e.g. for laptops or notebooks	A45C 3/02
---	---------------------------

Informative references*Attention is drawn to the following places, which may be of interest for search:*

Holders or carriers for portable audio devices	A45F 5/1508
Holders or carriers for portable handheld communication devices	A45F 5/1516
Holders or carriers for portable computing devices	A45F 5/1525
Supports for positioning or steadying a device relative to a person	F16M 13/04
Enclosures for carrying portable computers with peripheral devices	G06F 1/1628
Protective covers or auxiliary enclosures for portable computers	G06F 1/1629
Arrangements for carrying or protecting portable transceivers	H04B 1/3888
Protective covers or auxiliary enclosures for portable telephones	H04M 1/0203
Casings, cabinets or drawers for electric apparatus	H05K 5/00

Special rules of classification

If the device is a mobile phone that also has digital music playing capabilities and/or computing capabilities, it should only be classified in receptacles for portable handheld communication devices [A45C 11/002](#).

If the device is a computer or tablet that also has digital music playing capabilities and/or communication capabilities, it should only be classified in receptacles for portable computing devices [A45C 11/003](#).

Glossary of terms*In this place, the following terms or expressions are used with the meaning indicated:*

storing	to put or keep something in a receptacle for future use
---------	---

A45F5/1508

Definition statement

This place covers:

Holders or carriers worn by a user for hands-free carrying of portable audio devices like headphones or digital music players.

Illustrative examples of subject matter classified in this place:

1.



2.



Relationships with other classification places

Holders or carriers worn by a user for portable audio devices like headphones or digital audio players to facilitate transporting or carrying, where the device is not in use or being passively used are classified in [A45F 5/1508](#) while holders or carriers being worn by a user for portable handheld communication devices and portable computing devices are classified in groups [A45F 5/1516](#) and [A45F 5/1525](#), respectively.

DATE: JANUARY 1, 2025

PROJECT RP10469

This place relates to holders or carriers worn by a user for portable audio devices like headphones or digital audio players to facilitate transporting or carrying, where the device is not in use or being passively used.

Holders or carriers being worn by a user for portable handheld communication devices and portable computing devices are classified in groups [A45F 5/1516](#) and [A45F 5/1525](#), respectively.

Receptacles for storing portable audio devices, portable handheld communication devices or portable computing devices where the device must be removed for use are classified in [A45C 11/001](#), [A45C 11/002](#) and [A45C11/003](#), respectively.

Protective covers or auxiliary enclosures for portable computers that are intended to hold the device during use without hampering said use are classified in [G06F 1/1629](#).

Protective covers or auxiliary enclosures for mobile phones that are intended to hold the device during use without hampering the telephonic functions are classified in [H04M 1/0203](#).

Constructional features, like venting or EMI shielding means, of electronic housings not characterised by the inner electronic arrangements are classified in [H05K 5/00](#).

Supports for positioning or steadying a device relative to a person with the intent of using the device are classified in [F16M 13/04](#).

References

Informative references

Attention is drawn to the following places, which may be of interest for search:

Receptacles for storing portable audio devices like headphones or digital music players	A45C 11/001
Receptacles for storing portable handheld communication devices, e.g. pagers or smart phones	A45C 11/002
Receptacles for storing portable computing devices, e.g. laptops, tablets or calculators	A45C 11/003
Supports for positioning or steadying a device relative to a person	F16M 13/04
Enclosures for carrying portable computers with peripheral devices	G06F 1/1628
Protective covers or auxiliary enclosures for portable computers	G06F 1/1629
Wearable computers, e.g. on a belt	G06F 1/163
Arrangements for carrying or protecting portable transceivers	H04B 1/3888
Protective covers or auxiliary enclosures for portable telephones	H04M 1/0203
Casings, cabinets or drawers for electric apparatus	H05K 5/00

Special rules of classification

If the device is a mobile phone that also has digital audio playing capabilities and/or computing capabilities, it should only be classified in holders or carriers for portable handheld communication devices [A45F 5/1516](#).

If the device is a computer or tablet that also has digital audio playing capabilities and/or computing capabilities, it should only be classified in holders or carriers for portable computing devices [A45F 5/1525](#).

A45F5/1516

Definition statement

This place covers:

Holders or carriers worn by a user for hands-free carrying of portable handheld communication devices.

Illustrative examples of subject matter classified in this place:

1.

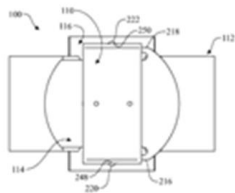

2.

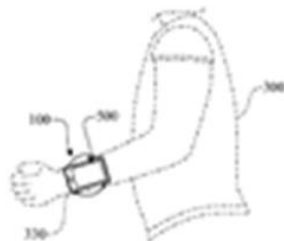

3.

DATE: JANUARY 1, 2025

PROJECT RP10469

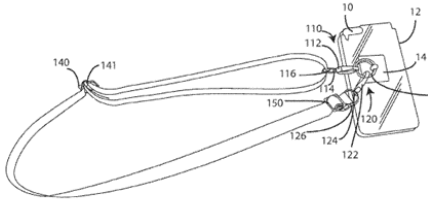

Relationships with other classification places

Holders or carriers worn by a user for portable handheld communication devices to facilitate transporting or carrying, where the device is not in use or being passively used are classified in [A45F 5/1516](#) while receptacles for storing portable audio devices, portable handheld communication devices or portable computing devices where the device must be removed for use are classified in [A45C 11/001](#), [A45C 11/002](#) and [A45C 11/003](#), respectively.

Protective covers or auxiliary enclosures for portable computers that are intended to hold the device during use without hampering said use are classified in [G06F 1/1629](#).

Protective covers or auxiliary enclosures for mobile phones that are intended to hold the device during use without hampering the telephonic functions are classified in [H04M 1/0203](#).

Constructional features, like venting or EMI shielding means, of electronic housings not characterised by the inner electronic arrangements are classified in [H05K 5/00](#).

Supports for positioning or steadying a device relative to a person with the intent of using the device are classified in [F16M 13/04](#).

References

Informative references

Attention is drawn to the following places, which may be of interest for search:

Receptacles for storing portable audio devices like headphones or digital audio players	A45C 11/001
Receptacles for storing portable handheld communication devices, e.g. pagers or smart phones	A45C 11/002

DATE: JANUARY 1, 2025

PROJECT RP10469

Receptacles for storing portable computing devices, e.g. laptops, tablets or calculators	A45C 11/003
Supports for positioning or steadying a device relative to a person	F16M 13/04
Enclosures for carrying portable computers with peripheral devices	G06F 1/1628
Protective covers or auxiliary enclosures for portable computers	G06F 1/1629
Wearable computers, e.g. on a belt	G06F 1/163
Arrangements for carrying or protecting portable transceivers	H04B 1/3888
Protective covers or auxiliary enclosures for portable telephones	H04M 1/0203
Casings, cabinets or drawers for electric apparatus	H05K 5/00

Special rules of classification

If the device is a mobile phone that also has computing capabilities and/or digital audio playing capabilities, it should only be classified in holders or carriers for portable handheld communication devices [A45F 5/1516](#).

If the device is a computer or tablet that also has communication capabilities and/or digital audio playing capabilities, it should only be classified in holders or carriers for portable computing devices [A45F 5/1525](#).

[A45F5/1525](#)

Definition statement

This place covers:

Holders or carriers worn by a user for hands-free carrying of portable handheld computing devices like laptops, tablets or calculators.

Illustrative examples of subject matter classified in this place:

1.

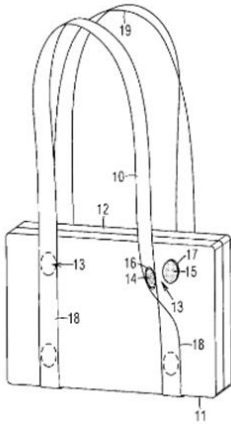

2.

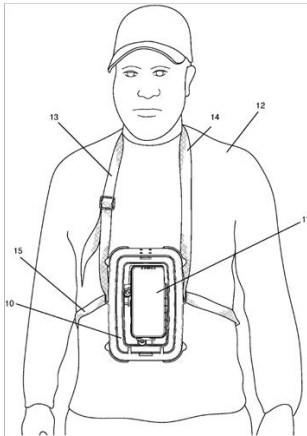

Relationships with other classification places

Holders or carriers worn by a user holding or carrying portable handheld computing devices like laptops, tablets or calculators to facilitate transporting or carrying, where the device is not in use or being passively used are classified in [A45F 5/1525](#), while carrying devices like bands or straps worn on the user to which a computer is attached, e.g. by snapping, are therefore classified in this group. Portable computers, e.g. smart watches, whereby the portable computer itself is worn by the user, are classified in group [G06F 1/163](#).

Receptacles for storing portable audio devices, portable handheld communication devices or portable computing devices where the device must be removed for use are classified in [A45C 11/001](#), [A45C 11/002](#) and [A45C 11/003](#), respectively.

Protective covers or auxiliary enclosures for portable computers that are intended to hold the device during use without hampering said use are classified in [G06F 1/1629](#).

DATE: JANUARY 1, 2025

PROJECT RP10469

Protective covers or auxiliary enclosures for mobile phones that are intended to hold the device during use without hampering the telephonic functions are classified in [H04M 1/0203](#).

Constructional features, like venting or EMI shielding means, of electronic housings not characterised by the inner electronic arrangements are classified in [H05K 5/00](#).

Supports for positioning or steadying a device relative to a person with the intent of using the device are classified in [F16M 13/04](#).

References

Informative references

Attention is drawn to the following places, which may be of interest for search:

Receptacles for storing portable audio devices like headphones or digital music players	A45C 11/001
Receptacles for storing portable handheld communication devices, e.g. pagers or smart phones	A45C 11/002
Receptacles for storing portable computing devices, e.g. laptops, tablets or calculators	A45C 11/003
Supports for positioning or steadying a device relative to a person	F16M 13/04
Enclosures for carrying portable computers with peripheral devices	G06F 1/1628
Protective covers or auxiliary enclosures for portable computers	G06F 1/1629
Wearable computers, e.g. on a belt	G06F 1/163
Arrangements for carrying or protecting portable transceivers	H04B 1/3888
Protective covers or auxiliary enclosures for portable telephones	H04M 1/0203
Casings, cabinets or drawers for electric apparatus	H05K 5/00

Special rules of classification

If the device is a mobile phone that also has computing capabilities and/or digital audio playing capabilities, it should only be classified in holders or carriers for portable handheld communication devices [A45F 5/1516](#).

If the device is a computer or tablet that also has digital music playing capabilities or communication capabilities, it should only be classified in holders or carriers for portable computing devices [A45F 5/1525](#).

A45F5/1533

Definition statement

This place covers:

Holders or carriers worn by a user for hands-free carrying of cameras.

Illustrative examples of subject matter classified in this place:

1.

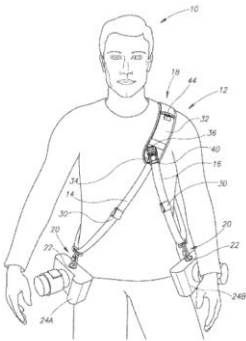

2.

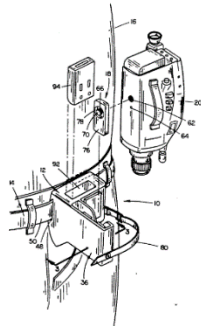

3.

DATE: JANUARY 1, 2025

PROJECT RP10469

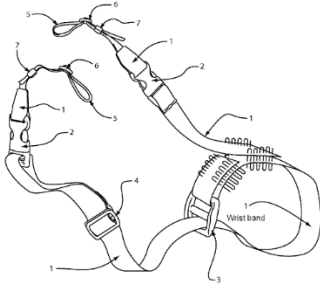

Relationships with other classification places

This place relates to holders or carriers worn by a user holding or carrying cameras to facilitate transporting or carrying, where the device is not in use. Carrying devices like bands or straps worn on the user to which a camera is attached, e.g. by snapping, are therefore classified in this place.

Cases or bags for storing cameras are classified in [A45C 11/38](#).

References

Informative references

Attention is drawn to the following places, which may be of interest for search:

Camera cases	A45C 11/38
Accessories for cameras	G03B 17/56

[A45F5/1588](#)

Definition statement

This place covers:

Illustrative example of subject matter classified in this place:

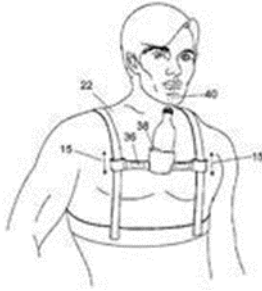

G06F1/1629

Definition statement

This place covers:

Protective covers or auxiliary enclosures for portable computers that are intended to hold the device during use without hampering said use. The covers or enclosures for portable computers are in principle detachable but intended to remain on the computer during use.

Illustrative example of subject matter classified in this place:

1a.

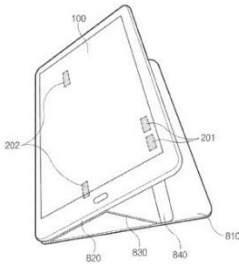

1b.

DATE: JANUARY 1, 2025

PROJECT RP10469

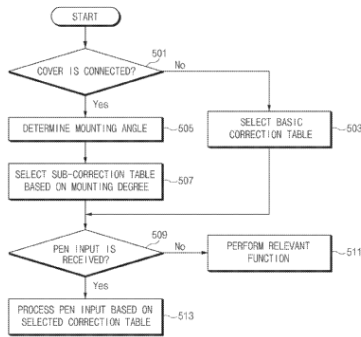

1c.

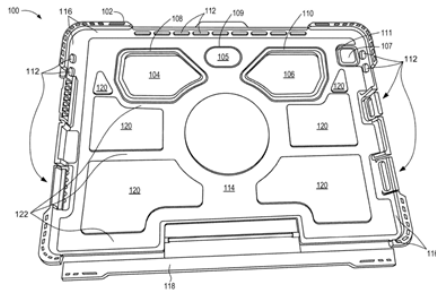

Relationships with other classification places

Protective covers or auxiliary enclosures for portable computers that are intended to hold the device during use are classified in [G06F 1/1629](#) while receptacles for storing portable audio devices, portable handheld communication devices or portable computing devices where the device must be removed for use are classified in [A45C 11/001](#), [A45C 11/002](#) and [A45C 11/003](#), respectively.

In the context of subclass [A45C](#), storing is understood as to refer to putting or keeping something in a receptacle for future use.

Holders or carriers being worn by a user for portable audio devices, portable handheld communication devices and portable computing devices to facilitate transporting or carrying, where the device is not in use or being passively used, are classified in groups [A45F 5/1508](#), [A45F 5/1516](#) and [A45F 5/1525](#), respectively.

Protective covers or auxiliary enclosures for mobile phones that are intended to hold the device during use without hampering the telephonic functions are classified in [H04M 1/0203](#).

Constructional features, like venting or EMI shielding means, of electronic housings not characterised by the inner electronic arrangements are classified in [H05K 5/00](#).

DATE: JANUARY 1, 2025

PROJECT RP10469

Supports for positioning or steadying a device relative to a person with the intent of using the device are classified in [F16M 13/04](#).

References

Limiting references

This place does not cover:

Receptacles for storing portable computing devices, e.g. laptops, tablets or calculators	A45C 11/003
Enclosures for carrying portable computers with peripheral devices	G06F 1/1628

Informative references

Attention is drawn to the following places, which may be of interest for search:

Receptacles for storing portable audio devices like headphones or digital music players	A45C 11/001
Receptacles for storing portable handheld communication devices, e.g. pagers or smart phones	A45C 11/002
Holders or carriers for portable audio devices	A45F 5/1508
Holders or carriers for portable handheld communication devices	A45F 5/1516
Holders or carriers for portable computing devices	A45F 5/1525
Supports for positioning or steadying a device relative to a person	F16M 13/04
Arrangements for carrying or protecting portable transceivers	H04B 1/3888
Protective covers or auxiliary enclosures for portable telephones	H04M 1/0203
Casings, cabinets or drawers for electric apparatus	H05K 5/00

Special rules of classification

Enclosures for carrying portable computers with peripheral devices, like a printer or a charger, are classified in [G06F 1/1628](#).

Details related to functional adaptations of the enclosures, e.g. to provide protection against EMI, shock or water are identified by allocating further classification in [G06F 1/1656](#) or subgroups.

DATE: JANUARY 1, 2025

PROJECT RP10469

H04B1/385**Relationships with other classification places**

Holders or carriers being worn by a user for portable audio devices, portable handheld communication devices and portable computers to facilitate transporting or carrying, where the device is not in use or being passively used, are classified in groups [A45F 5/1508](#), [A45F 5/1516](#) and [A45F 5/1525](#), respectively.

Supports for positioning or steadying a device relative to a person with the intent of using the device are classified in [F16M 13/04](#).

References**Informative references**

Attention is drawn to the following places, which may be of interest for search:

Receptacles for storing portable audio devices like headphones or digital music players	A45C 11/001
Receptacles for storing portable handheld communication devices, e.g. pagers or smart phones	A45C 11/002
Receptacles for storing portable computing devices, e.g. laptops, tablets or calculators	A45C 11/003
Holders or carriers for portable audio devices	A45F 5/1508
Holders or carriers for portable handheld communication devices	A45F 5/1516
Holders or carriers for portable computers	A45F 5/1525
Supports for positioning or steadying a device relative to a person	F16M 13/04
Enclosures for carrying portable computers with peripheral devices	G06F 1/1628
Protective covers or auxiliary enclosures for portable computers	G06F 1/1629
Wearable computers, e.g. on a belt	G06F 1/163
Arrangements for carrying or protecting portable transceivers	H04B 1/3888
Protective covers or auxiliary enclosures for portable telephones	H04M 1/0203
Casings, cabinets or drawers for electric apparatus	H05K 5/00

DATE: JANUARY 1, 2025

PROJECT RP10469

H04B1/3888**Relationships with other classification places**

Protective covers or auxiliary enclosures specially adapted for portable computers or mobile telephones for protecting these devices during use are classified in [G06F 1/1629](#) and [H04M 1/0203](#), respectively.

In the context of subclass [A45C](#), storing is understood as to refer to putting or keeping something in a receptacle for future use.

Receptacles for storing portable audio devices, portable handheld communication devices or portable computing devices where the device must be removed for use are classified in [A45C 11/001](#), [A45C 11/002](#) and [A45C 11/003](#), respectively.

Informative references

Attention is drawn to the following places, which may be of interest for search:

Receptacles for storing portable audio devices like headphones or digital music players	A45C 11/001
Receptacles for storing portable handheld communication devices, e.g. pagers or smart phones	A45C 11/002
Receptacles for storing portable computing devices, e.g. laptops, tablets or calculators	A45C 11/003
Holders or carriers for portable audio devices	A45F 5/1508
Holders or carriers for portable handheld communication devices	A45F 5/1516
Holders or carriers for portable computing devices	A45F 5/1525
Protective covers or auxiliary enclosures for portable computers	G06F 1/1629
Constructional details of transmitters, e.g. casings or housings	H04B 1/03
Constructional details of receivers, e.g. cabinets	H04B 1/08
Arrangements for enabling portable transceivers to be used in a fixed position, e.g. cradles or boosters	H04B 1/3877
Protective covers or auxiliary enclosures for portable telephones	H04M 1/0203
Casings, cabinets or drawers for electric apparatus	H05K 5/00

H04M1/0203

Definition statement

This place covers:

Protective covers or auxiliary enclosures for mobile telephones holding the device during use without hampering said use. The covers or enclosures for mobile telephones are in principle detachable, but intended to remain on the mobile telephone during use. The cover or enclosure provides features, e.g. openings, notches or bumpers, that enable the use of the mobile phone. The protection can be various, e.g. to hazardous environments, for improving heat dissipation or resistance to shocks.

Illustrative examples of subject matter classified in this place:

1.

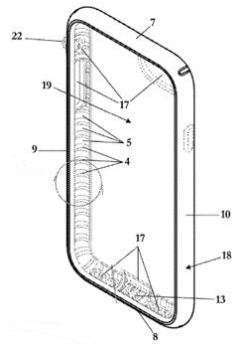

2.

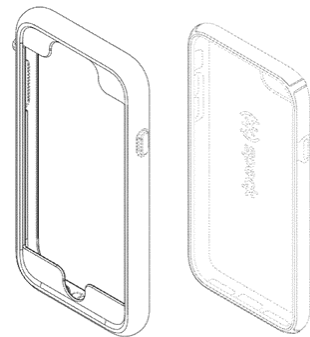

Relationships with other classification places

Protective covers or auxiliary enclosures for mobile telephones that are intended to hold the device during use are classified in [H04M 1/0203](#) while receptacles for storing

DATE: JANUARY 1, 2025

PROJECT RP10469

portable audio devices, portable handheld communication devices or portable computing devices where the device must be removed for use are classified in [A45C 11/001](#), [A45C 11/002](#) and [A45C 11/003](#), respectively.

In the context of subclass [A45C](#), storing is understood as to refer to putting or keeping something in a receptacle for future use.

Enclosures for carrying portable computers with peripheral devices, like a printer or a charger, are classified in [G06F 1/1628](#).

Holders or carriers being worn by a user for portable audio devices, portable handheld communication devices and portable computing devices to facilitate transporting or carrying, where the device is not in use or being passively used, are classified in groups [A45F5/1508](#), [A45F5/1516](#) and [A45F 5/1525](#), respectively.

Protective covers or auxiliary enclosures for portable computers that are intended to hold the device during use without hampering said use are classified in [G06F 1/1629](#).

Constructional features, like venting or EMI shielding means, of electronic housings not characterised by the inner electronic arrangements are classified in [H05K 5/00](#).

Supports for positioning or steadying a device relative to a person with the intent of using the device are classified in [F16M 13/04](#).

References

Limiting references

This place does not cover:

Receptacles for storing portable handheld communication devices, e.g. pagers or smart phones	A45C 11/002
--	-----------------------------

Informative references

Attention is drawn to the following places, which may be of interest for search:

Receptacles for storing portable audio devices like headphones or digital music players	A45C 11/001
Receptacles for storing portable computing devices, e.g. laptops, tablets or calculators	A45C 11/003

DATE: JANUARY 1, 2025

PROJECT RP10469

Holders or carriers for portable audio devices	A45F 5/1508
Holders or carriers for portable handheld communication devices	A45F 5/1516
Holders or carriers for portable computing devices	A45F 5/1525
Supports for positioning or steadying a device relative to a person	F16M 13/04
Protective covers or auxiliary enclosures for portable computers	G06F 1/1629
Arrangements for carrying or protecting portable transceivers	H04B 1/3888
Telephone sets specially adapted for use in ships, mines or other places exposed to adverse environment	H04M 1/18
Casings, cabinets or drawers for electric apparatus	H05K 5/00

Special rules of classification

Features relating to further aspects concerning hygiene, e.g. integrated sanitizers or antiviral aspects are identified by allocating further classification in [H04M 1/17](#).

Features relating to further improving the user comfort by providing a decorative aspect are identified by allocating further classification in [H04M 1/0283](#).

Fastening means of holding devices supporting portable telephones are classified in [H04M 1/04](#).

[H04M1/185](#)

Definition statement

This place covers:

Improvements to shock resistance of the housing, where the housing is the fixed enclosure of the telephone.

Illustrative examples of subject matter classified in this place:

1.

DATE: JANUARY 1, 2025

PROJECT RP10469

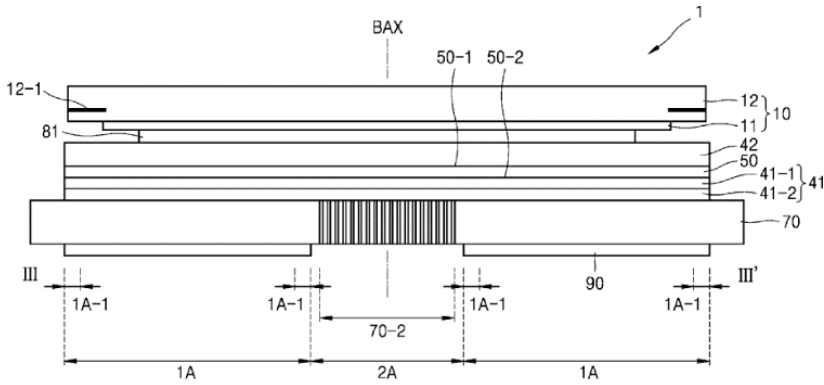
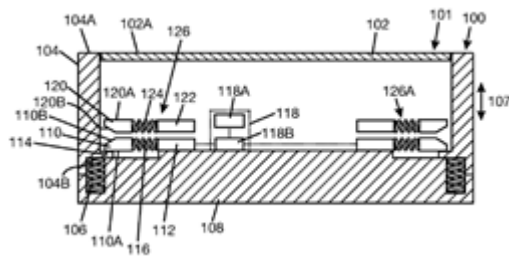
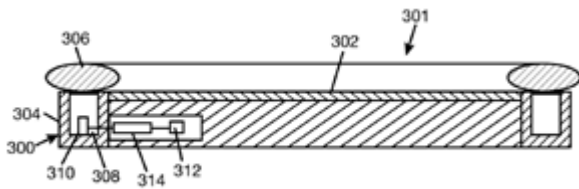

Figure 1 illustrates how the display panel is protected from being damaged by collisions by means of shock absorbers (90) provided under a heat dissipating plate (70) and the display panel (50).

2.



3.



4.

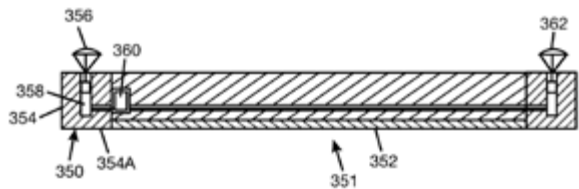

DATE: JANUARY 1, 2025

PROJECT RP10469

5.

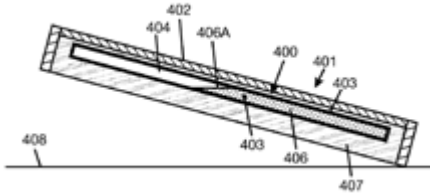

6.

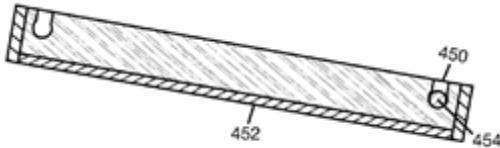

7.

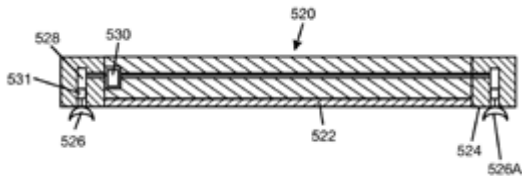

Figures 2-7 illustrate several structural features for actively protecting a cover glass of a display device, when detecting that the device is in free fall. The example includes extending a bezel (104) around the display by springs or shape memory alloy, deploying an airbag (306) or parachute (356), changing the angular momentum by moving of a fluid in an internal chamber (404) or a set of balls in a track (450), so that the device lands on its side as well as deploying a suction cup (526).

Informative references

Attention is drawn to the following places, which may be of interest for search:

Protective covers or auxiliary enclosures for portable telephones	H04M 1/0203
---	-----------------------------

2. A. DEFINITIONS (modified)

A45C11/00

Definition statement

Replace: The existing Definition statement with the following.

Receptacles of relatively small dimension characterised by their purpose of use.

Illustrative examples of subject matter classified in this place:

1.



2.



3.



Delete: The entire Limiting references section.

DATE: JANUARY 1, 2025

PROJECT RP10469

ReferencesInsert: The following new Application-oriented references section.***Application-oriented references****Examples of places where the subject matter of this place is covered when specially adapted, used for a particular purpose, or incorporated in a larger system:*

Boxes, cases, etuis or the like specially adapted for manicure or pedicure sets	A45D 29/20
Receptacles for hair brushes or tooth brushes as travelling equipment	A45D 44/18
Sewing kits	A45F 3/48

Informative referencesReplace: The existing Informative references table with the following updated table.

Holders or carriers for hand articles; Holders or carriers for use while travelling or camping	A45F 5/00
Fastening articles to the garment	A45F 5/02
Doctors' or nurses' bags	A61B 50/312
First-aid kits	A61F 17/00
Devices for carrying bowling balls	A63B 47/007
Making paper articles; Working paper	B31
Writing implement receptacles functioning as, or combined with, writing implements	B43K 31/00
Containers, packaging elements or packages, specially adapted for particular articles or materials; For pencils or pens	B65D 85/28
Containers, packaging elements or packages, specially adapted for particular articles or materials; For optical or other delicate measuring, calculating or control apparatus	B65D 85/38

Insert: The following new Special rules section.

Special rules of classification

References [A45D 29/20](#), [A45D 44/18](#) and [A45F 3/48](#) are non-limiting in the main group [A45C 11/00](#). CPC will be updated/corrected once this inconsistency is resolved in IPC.

A45C11/22

Definition statement

Replace: The existing Definition statement with the following updated text and images.

Illustrative examples of subject matter classified in this place:

1.

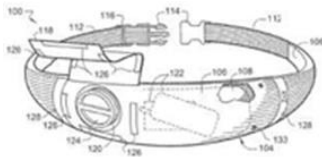

2.

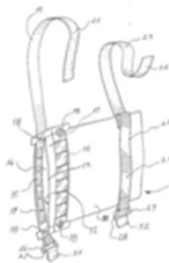

3.

CPC NOTICE OF CHANGES 1657

DATE: JANUARY 1, 2025

PROJECT RP10469



4a.

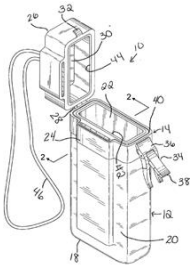

4b.

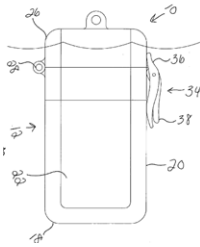

References

Informative references

Replace: The text in the left column of the following rows.

Details of receptacles for making water- or air-tight	A45C 13/008
Hermetically-sealed casings	H05K 5/06

A45C11/38

Definition statement

Replace: The existing Definition statement with the following updated text and images.

Illustrative examples of subject matter classified in this place:

1.

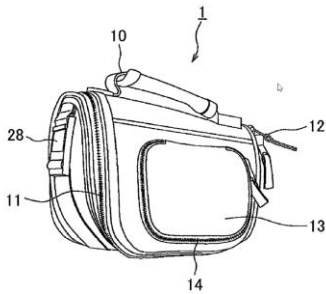

2.

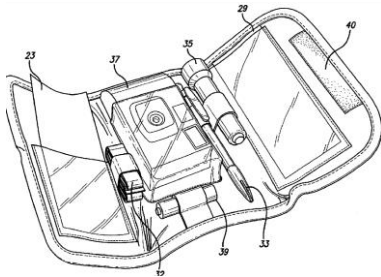

References

Informative references

Insert: The following two new rows to the Informative references table.

Holders or carriers for cameras	A45F 5/1533
Accessories for cameras	G03B 17/56

A45F3/16

Definition statement

Replace: The existing Definition statement with the following updated text and images.

Illustrative examples of subject matter classified in this place:

1.

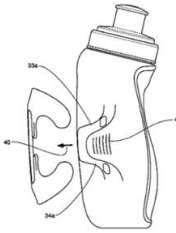

Figure 1 illustrates a contoured and angled bottle with mounting clip.

2.

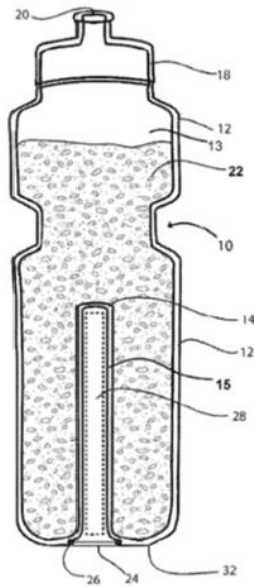

Figure 2 illustrates a bottle that has a secondary chamber (14) for storing personal items.

References

Informative references

Replace: The first row in the Informative references table with the following updated text.

Drinking straws as tableware	A47G 21/18
------------------------------	----------------------------

A45F4/02

Definition statement

Replace: The existing Definition statement with the following updated text and images.

Illustrative examples of subject matter classified in this place:

1.

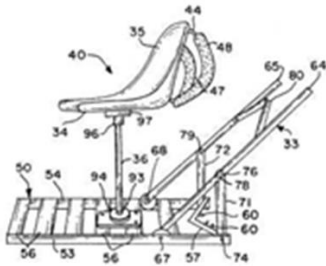

2.

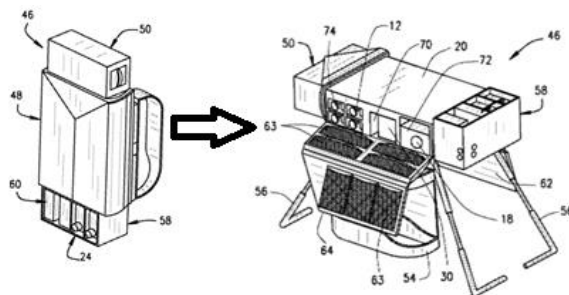

3.

DATE: JANUARY 1, 2025

PROJECT RP10469

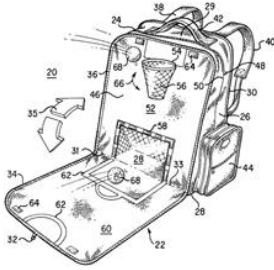

A45F5/00

Delete: The existing Definition statement.

References

Informative references

Replace: The text in the following row of the Informative references table.

Arrangements for carrying or protecting portable transceivers	H04B 1/3888
---	-----------------------------

Insert: The following new Glossary of terms section.

Glossary of terms

In this place, the following terms or expressions are used with the meaning indicated:

holder or carrier	a human body-supported device for holding or carrying hand articles to facilitate transport and/or hands-free carrying of the hand article, where the hand article is not in use or being passively used while supported by the wearer. For example, an armband, a shoulder-strap or a belt clip, each including means for retaining a hand article. The holder or carrier is not part of the hand article itself, e.g. it is distinct from the housing of an electronic device. Holders or carriers do not include sacks or packs.
-------------------	---

A45F5/14

Definition statement

Replace: The existing Definition statement with the following updated text and images.

Illustrative examples of subject matter classified in this place:

1.

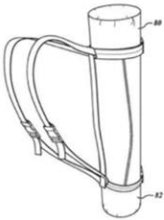

2.

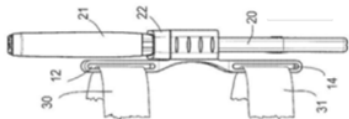

3.

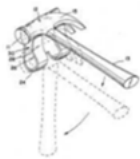

4.

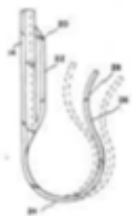

DATE: JANUARY 1, 2025

PROJECT RP10469

G06F1/1613

Definition statement

Delete: In the first sentence of the Definition statement, the space between the words “stand” and “alone”, so that it reads “standalone” and the text appears as follows.

Portable computers in the sense of computers able to be used as standalone computers with their own integrated user interface and designed to be carried by hand (e.g. hand held computers or laptop computers) or worn on the user's body (wearable computers).

Docking stations and extensions associated with the portable computers which may be mechanically attached to them.

Delete: The entire Relationships section.

References

Limiting references

Delete: The third, fourth, fifth, and sixth rows of the Limiting references table, so that the new table appears as follows.

Cooling arrangements for portable computers	G06F 1/203
Constructional details or arrangements for pocket calculators, electronic agendas or books	G06F 15/0216
Constructional details of portable telephone sets: with several bodies	H04M 1/0202

Insert: The following new Informative references table.

Informative references

Attention is drawn to the following places, which may be of interest for search:

DATE: JANUARY 1, 2025

PROJECT RP10469

Anti-theft locking devices	E05B 73/0082
Constructional details of cameras	G03B 17/00
Hand held scanners	G06K 7/10881
Personal calling arrangements, i.e. paging systems or devices, i.e. pagers	G08B 5/222
Casing of remote controls	H01H 9/0235
Cameras or camera modules comprising electronic image sensors	H04N 23/00
Telephone sets including user guidance or feature selection means facilitating their use	H04M 1/247
Cordless telephones	H04M 1/725

Synonyms and Keywords

Replace: The existing Synonyms and Keywords text with the following updated text.

In patent documents, the following words/expressions are often used as synonyms:

- "laptop", "palmtop" and "PDA"
- " cell phone", "mobile phone" and "smart phone"

G06F1/1628

Definition statement

Replace: The existing Definition statement with the following updated text and new images.

Portable enclosures allowing the transport of the portable computer together with other peripherals.

Illustrative examples of subject matter classified in this place:

- 1.

DATE: JANUARY 1, 2025

PROJECT RP10469

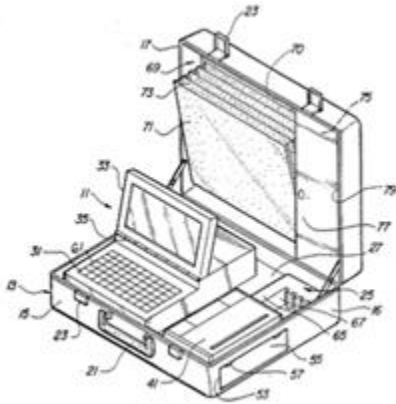

2.

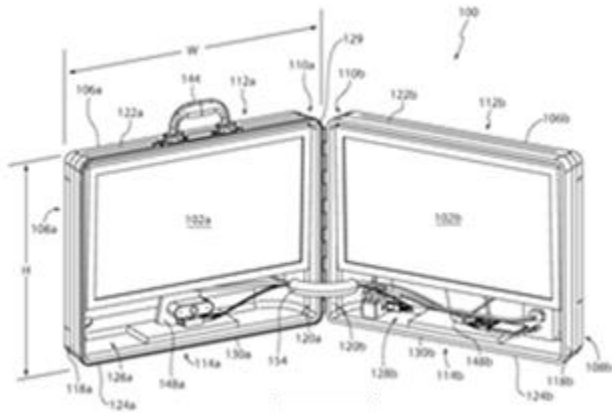

Figure 2 illustrates a portable system for carrying a monitor and a computing device in a case.

Insert: The following new Relationships section.

Relationships with other classification places

In the context of subclass [A45C](#), storing is understood as to refer to putting or keeping something in a receptacle for future use.

Receptacles for storing portable audio devices, portable handheld communication devices or portable computing devices where the device must be removed for use are classified in [A45C 11/001](#), [A45C 11/002](#) and [A45C 11/003](#), respectively.

CPC NOTICE OF CHANGES 1657

DATE: JANUARY 1, 2025

PROJECT RP10469

Holders or carriers being worn by a user for portable audio devices, portable handheld communication devices and portable computing devices to facilitate transporting or carrying, where the device is not in use or being passively used, are classified in groups [A45F 5/1508](#), [A45F 5/1516](#) and [A45F 5/1525](#), respectively.

Protective covers or auxiliary enclosures for mobile phones that are intended to hold the device during use without hampering the telephonic functions are classified in [H04M 1/0203](#).

Constructional features, like venting or EMI shielding means, of electronic housings not characterised by the inner electronic arrangements are classified in [H05K 5/00](#).

References

Delete: The entire Limiting references section.

Informative references

Replace: The existing Informative references table with the following updated table.

Protective covers or auxiliary enclosures for portable computers	G06F 1/1629
Bags	A45C
Receptacles for storing portable computing devices, e.g. laptops, tablets or calculators	A45C 11/003
Holders or carriers for portable computing devices, e.g. laptops, tablets or calculators	A45F 5/1525
Stands with or without wheels as supports for apparatus	F16M 11/00
Arrangements for carrying or protecting portable transceivers in general	H04B 1/3888

DATE: JANUARY 1, 2025

PROJECT RP10469

Insert: The following new Special rules section.

Special rules of classification

Enclosures for carrying portable computers with peripheral devices, like a printer or a charger, are classified in [G06F 1/1628](#).

[G06F 1/1629](#) relates to protective covers or auxiliary enclosures for portable computers that are intended to hold the device during use. Details related to functional adaptations of the enclosures, e.g. to provide protection against EMI, shock or water are identified by allocating further classification in [G06F 1/1656](#) or subgroups.

G06F1/163

Insert: The following new Definition statement.

Definition statement

This place covers:

Portable computers, e.g. smart watches, whereby the portable computer itself is worn by a user.

Insert: The following new Relationships section.

Relationships with other classification places

Carrying devices like bands or straps worn on the user to which a computer is attached for facilitating transport or carrying when the computer is not in use or being passively used, e.g. belt clip with means for retaining a tablet, the tablet being removed from the belt clip for use, is classified in [A45F 5/1525](#).

DATE: JANUARY 1, 2025

PROJECT RP10469

References***Informative references***

Replace: The existing Informative references table with the following updated table.

Garments adapted to accommodate electronic equipment	A41D 1/002
Fastening articles to garments	A45F 5/02
Holders or carriers for portable computing devices, e.g. laptops, tablets or calculators	A45F 5/1525

G06F1/1656**References*****Limiting references***

Replace: The existing Limiting references table with the following updated table.

Arrangements to protect the display from incident light, e.g. hoods	G06F 1/1603
Arrangements to support accessories mechanically attached to the display housing	G06F 1/1607
Enclosure details of non-portable computers	G06F 1/181
Cooling arrangements for portable computers	G06F 1/203

Informative references

Replace: The existing Informative references table with the following updated table.

Protective covers or auxiliary enclosures for portable computers	G06F 1/1629
Protective covers or auxiliary enclosures for portable telephones	H04M 1/0203
Portable telephones with mechanically detachable modules	H04M 1/0254

H04M1/04

Definition statement

Replace: The existing Definition statement with the following updated text and images.

Constructional features, e.g. fastening means of a holster, holding device or docking station supporting a portable telephone.

Illustrative example of subject matter classified in this place:

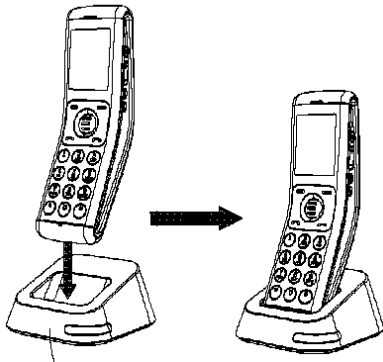

Relationships with other classification places

Replace: The existing Relationships text with the following updated text.

Supports for portable telephones covering constructional features of holsters, holding devices or docking stations that are supporting portable telephones directly or indirectly through connection means are classified in [H04M 1/04](#) while supports for a hand-held apparatus or articles in general are classified in [F16M 13/00](#).

Supports for positioning or steadying a device relative to a person with the intent of using the device are classified in [F16M 13/04](#).

Stands or trestles as supports for articles placed thereon in general are classified in [F16M 11/00](#).

CPC NOTICE OF CHANGES 1657

DATE: JANUARY 1, 2025

PROJECT RP10469

Holders or carriers being worn by a user for portable audio devices, portable handheld communication devices and portable computing devices to facilitate transporting or carrying, where the device is not in use or being passively used, are classified in groups [A45F 5/1508](#), [A45F 5/1516](#) and [A45F 5/1525](#), respectively.

Protective covers or auxiliary enclosures for portable computers that are intended to hold the device during use without hampering said use are classified in [G06F 1/1629](#).

References

Informative references

Replace: The existing Informative references table with the following updated table.

Protective covers or auxiliary enclosures for portable telephones	H04M 1/0203
Supports for a fixed telephone set	H04M 1/11
Holders or carriers for portable audio devices	A45F 5/1508
Holders or carriers for portable handheld communication devices	A45F 5/1516
Holders or carriers for portable computing devices	A45F 5/1525
Docking stations designed for portable telephones in vehicles	B60R 11/0241
Stands or trestles as supports for apparatus or articles placed thereon	F16M 11/00
Other supports for positioning apparatus or articles; Means for steadying hand-held apparatus or articles	F16M 13/00
Supports integral with the apparatus or articles to be supported	F16M 13/005
Protective covers or auxiliary enclosures for portable computers	G06F 1/1629
Docking stations designed for portable computers	G06F 1/1632
Battery charging apparatuses	H02J 7/00
Arrangements for carrying or protecting portable transceivers	H04B 1/3888
Transducers in general	H04R 1/00

Special rules of classification

Replace: The existing Special rules text with the following updated text.

Protective covers or auxiliary enclosures for mobile phones that are intended to hold the device during use without hampering the telephonic functions are classified in [H04M 1/0203](#).

When the docking station provides additional functionality to the portable telephone, [H04M 1/72409](#) should be used.

Insert: The following new Glossary of terms section.

Glossary of terms

In this place, the following terms or expressions are used with the meaning indicated:

stand	a rack, base or piece of furniture for holding, supporting or displaying something
support	element that bears the weight to keep something in position, e.g. to keep it upright

H04M1/17

Insert: The following new Definition statement.

Definition statement

This place covers:

Features of telephone equipment to improve hygiene, e.g. integrated sanitizers, antiviral smartphone covers or speaker covers to prevent transmission of airborne particles.

DATE: JANUARY 1, 2025

PROJECT RP10469

References

Insert: The following new Informative references table.

Informative references

Attention is drawn to the following places, which may be of interest for search:

Protective covers or auxiliary enclosures for portable telephones	H04M 1/0203
Methods or apparatus for disinfecting or sterilising materials or objects other than foodstuffs or contact lenses; Accessories therefor	A61L 2/00

H04M1/18

Definition statement

Replace: The existing Definition statement with the following updated text.

Fixed telephone sets or mobile phones specially adapted for use in adverse conditions, e.g. providing protection against dust, water, extreme temperatures, chemical fumes or gases, fire or explosions.

Relationships with other classification places

Delete: The entire Relationships section.

References

Insert: The following new Informative references table.

Informative references

Attention is drawn to the following places, which may be of interest for search:

CPC NOTICE OF CHANGES 1657

DATE: JANUARY 1, 2025

PROJECT RP10469

Telephone cabinets or booths per se	E04H 1/14
Dustproof, splashproof, drip-proof, waterproof or flameproof casings for keys or buttons	H01H 13/06
Protective enclosures for remote control devices	H01H 9/0242
Hermetically sealed housings	H05K 5/06
Modified payphones	H04M 17/026

Insert: The following new Special rules section.

Special rules of classification

This place covers integral casings intended to improve the operability in adverse conditions. Protective covers or auxiliary enclosures for mobile phones that are intended to hold the device during use without hampering the telephonic functions are classified in [H04M 1/0203](#).

Insert: The following new Glossary of terms table.

Glossary of terms

In this place, the following terms or expressions are used with the meaning indicated:

casings	a cover or shell, integral with or forming the telephone housing, that encloses and protects the telephone components
---------	---

CPC NOTICE OF CHANGES 1657

DATE: JANUARY 1, 2025

PROJECT RP10469

3. REVISION CONCORDANCE LIST (RCL)

Type*	From CPC Symbol (existing)	To CPC Symbol(s)
C	A45C 11/00	A45C 11/00, A45C 11/001, A45C 11/002, A45C 11/003, G06F 1/1629, H04M 1/0203
D	A45C 2011/001	<administrative transfer to A45C 11/001 INV>
Q	A45C 11/001	A45C 11/001, G06F 1/1629, H04M 1/0203,
D	A45C 2011/002	<administrative transfer to A45C 11/002 INV>
Q	A45C 11/002	A45C 11/002, H04M 1/0203
D	A45C 2011/003	<administrative transfer to A45C 11/003 INV>
Q	A45C 11/003	A45C 11/003, G06F 1/1629, G06F 1/1656
D	A45F 2003/166	<administrative transfer to A45F 3/166 INV>
Q	A45F 3/166	A45F 3/166, A45F 5/1588
D	A45F 2200/00	<no transfer>
D	A45F 2200/05	<no transfer>
D	A45F 2200/0508	<administrative transfer to A45F 5/1508 INV>
D	A45F 2200/0516	<administrative transfer to A45F 5/1516 INV>
D	A45F 2200/0525	<administrative transfer to A45F 5/1525 INV>
D	A45F 2200/0533	<administrative transfer to A45F 5/1533 INV>
D	A45F 2200/0541	<administrative transfer to A45F 5/1541 INV>
D	A45F 2200/055	<administrative transfer to A45F 5/155 INV>
D	A45F 2200/0558	<administrative transfer to A45F 5/1558 INV>
D	A45F 2200/0566	<administrative transfer to A45F 5/1566 INV>
D	A45F 2200/0575	<administrative transfer to A45F 5/1575 INV>
D	A45F 2200/0583	<administrative transfer to A45F 5/1583 INV>
D	A45F 2200/0591	<no transfer>
C	G06F 1/1613	G06F 1/1613, G06F 1/1629
C	G06F 1/1628	G06F 1/1628, A45C 11/003, G06F 1/1629
F	G06F 2200/1633	A45C 11/003, G06F 1/1629, G06F 1/1656, H04M 1/0203
C	H04B 2001/3855	H04B 2001/3855, A45F 5/1516
C	H04B 2001/3861	H04B 2001/3861, A45F 5/1516
C	H04B 1/3888	H04B 1/3888, A45C 11/002, A45C 11/003, G06F 1/1629, H04M 1/0203
C	H04M 1/18	H04M 1/18, H04M 1/0203
C	H04M 1/185	H04M 1/185, H04M 1/0203, H04M 1/18

* C = entries with modified file scope where reclassification of documents from the entries is involved; Q = new entries which are firstly populated with documents via administrative transfers from deleted (D) entries. Afterwards, the transferred documents into the Q entry will either stay or be moved to more appropriate entries, as determined by intellectual reclassification; D = deleted entries; F = frozen entries will be deleted once reclassification of documents from the entries is completed.

NOTES:

- Only C, D, F, and Q type entries are included in the table above.
- When multiple symbols are included in the “To” column, do not use ranges of symbols.
- For administrative transfer of documents, the following text should be used: “< administrative transfer to XX>”, “<administrative transfer to XX and YY simultaneously>”, or “<administrative transfer to XX, YY, ...and ZZ simultaneously>” when administrative transfer of the same documents is to more than one place.
- Administrative transfer to main trunk groups is assumed to be the source allocation type, unless otherwise indicated.
- Administrative transfer to 2000/Y series groups is assumed to be “additional information”.
- If needed, instructions for allocation type should be indicated within the angle brackets using the abbreviations “ADD” or “INV”: <administrative transfer to XX ADD>, <administrative transfer to XX INV>, or < administrative transfer to XX ADD, YY INV, ... and ZZ ADD simultaneously>.
- In certain situations, the “D” entries of 2000-series or Y-series groups may not require a destination (“To”) symbol, however it is required to specify “<no transfer>” in the “To” column for such cases.

CPC NOTICE OF CHANGES 1657

DATE: JANUARY 1, 2025

PROJECT RP10469

- RCL is not needed for finalisation projects.

CPC NOTICE OF CHANGES 1657

DATE: JANUARY 1, 2025

PROJECT RP10469

4. CHANGES TO THE CPC-TO-IPC CONCORDANCE LIST (CICL)

<u>CPC</u>	<u>IPC</u>	<u>Action*</u>
A45C 2011/001		DELETE
A45C 11/001	A45C 11/00	NEW
A45C 2011/002		DELETE
A45C 11/002	A45C 11/00	NEW
A45C 2011/003		DELETE
A45C 11/003	A45C 11/00	NEW
A45F 2003/166		DELETE
A45F 3/166	A45F 3/16	NEW
A45F 5/1508	A45F 5/00	NEW
A45F 5/1516	A45F 5/00	NEW
A45F 5/1525	A45F 5/00	NEW
A45F 5/1533	A45F 5/00	NEW
A45F 5/1541	A45F 5/00	NEW
A45F 5/155	A45F 5/00	NEW
A45F 5/1558	A45F 5/00	NEW
A45F 5/1566	A45F 5/00	NEW
A45F 5/1575	A45F 5/00	NEW
A45F 5/1583	A45F 5/00	NEW
A45F 5/1588	A45F 5/00	NEW
A45F 2200/00		DELETE
A45F 2200/05		DELETE
A45F 2200/0508		DELETE
A45F 2200/0516		DELETE
A45F 2200/0525		DELETE
A45F 2200/0533		DELETE
A45F 2200/0541		DELETE
A45F 2200/055		DELETE
A45F 2200/0558		DELETE
A45F 2200/0566		DELETE
A45F 2200/0575		DELETE
A45F 2200/0583		DELETE
A45F 2200/0591		DELETE
G06F 1/1629	G06F 1/16	NEW
H04M 1/0203	H04M 1/02	NEW

*Action column:

- For an (N) or (Q) entry, provide an IPC symbol and complete the Action column with “NEW.”
- For an existing CPC main trunk entry or indexing entry where the existing IPC symbol needs to be changed, provide an updated IPC symbol and complete the Action column with “UPDATED.”
- For a (D) CPC entry or indexing entry complete the Action column with “DELETE.” IPC symbol does not need to be included in the IPC column.
- For an (N) 2000 series CPC entry which is positioned within the main trunk scheme (breakdown code) provide an IPC symbol and complete the action column with “NEW”.
- For an (N) 2000 series CPC entry positioned at the end of the CPC scheme (orthogonal code), with no IPC equivalent, complete the IPC column with “CPCONLY” and complete the action column with “NEW”.

CPC NOTICE OF CHANGES 1657

DATE: JANUARY 1, 2025

PROJECT RP10469

NOTES:

- F symbols are not included in the CACL table above.
- T and M symbols are not included in the CACL table above unless a change to the existing IPC is desired.

CPC NOTICE OF CHANGES 1657

DATE: JANUARY 1, 2025

PROJECT RP10469

5. CROSS-REFERENCE LIST (CRL)

Definitions references impacted by this revision project

<u>Location of reference to be changed</u>	<u>Referenced subclass or group to be changed</u>	<u>Section of definition</u>	<u>Action; New reference symbol; New text</u>
A44B 15/005	A45F 2200/0558	Limiting references	Replace current symbol with: A45F5/1558

NOTES:

- The CRL tables above are used for changes to locations **outside** of the project scope. Changes to references in scheme titles or definitions **inside** the project scope will be reflected in the “scheme change” template or one of the “definition” templates.
- In addition to other changes proposed in the tables above, in the column titled “Referenced subclass or group to be changed,” **referenced D** symbols should indicate an action of “delete” or should indicate a replacement symbol and **referenced F** symbols should indicate a replacement symbol.
- When a reference is deleted, text related to that reference will also be deleted unless other references or a range of references associated with the same text remain.